

Panasonic®

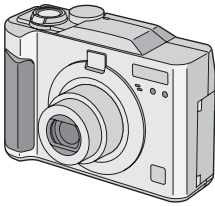

Digital Camera Operating Instructions

Model No. **DMC-LC33PP**



LEICA
DC VARIO-ELMARIT

Before use, please read these
instructions completely.

For USA assistance, please call: 1-800-272-7033 or send e-mail to : digitalstillcam@panasonic.com

For Canadian assistance, please call: 1-800-561-5505 or visit us at www.panasonic.ca

VQT0D36

Dear Customer,

We would like to take this opportunity to thank you for purchasing this Panasonic Digital Camera. Please read these Operating Instructions carefully and keep them handy for future reference.

Information for Your Safety

WARNING

TO REDUCE THE RISK OF FIRE OR SHOCK HAZARD AND ANNOYING INTERFERENCE, USE ONLY THE RECOMMENDED ACCESSORIES AND DO NOT EXPOSE THIS EQUIPMENT TO RAIN OR MOISTURE. DO NOT REMOVE THE COVER (OR BACK); THERE ARE NO USER SERVICEABLE PARTS INSIDE. REFER SERVICING TO QUALIFIED SERVICE PERSONNEL.

Notice:

This product has parts that contain a small amount of mercury. It also contains lead in some components. Disposal of these materials may be regulated in your community due to environmental considerations. For disposal or recycling information please contact your local authorities, or the Electronics Industries Alliance: <<http://www.eiae.org>>

Carefully observe copyright laws.

Recording of pre-recorded tapes or discs or other published or broadcast material for purposes other than your own private use may infringe copyright laws. Even for the purpose of private use, recording of certain material may be restricted.

- Please note that the actual controls and components, menu items, etc. of your Digital Camera may look somewhat different from those shown in the illustrations in these Operating Instructions.
- SD Logo is a trademark.
- Other names, company names, and product names printed in these instructions are trademarks or registered trademarks of the companies concerned.



A nickel metal hydride battery that is recyclable powers the product you have purchased. Please call 1-800-8-BATTERY for information on how to recycle this battery.

FCC Note: (U.S. only)

This equipment has been tested and found to comply with the limits for a Class B digital device, pursuant to Part 15 of the FCC Rules. These limits are designed to provide reasonable protection against harmful interference in a residential installation. This equipment generates, uses, and can radiate radio frequency energy and, if not installed and used in accordance with the instructions, may cause harmful interference to radio communications. However, there is no guarantee that interference will not occur in a particular installation. If this equipment does cause harmful interference to radio or television reception, which can be determined by turning the equipment off and on, the user is encouraged to try to correct the interference by one or more of the following measures:

- Reorient or relocate the receiving antenna.
- Increase the separation between the equipment and receiver.
- Connect the equipment into an outlet on a circuit different from that to which the receiver is connected.
- Consult the dealer or an experienced radio/TV technician for help.

FCC Caution: To assure continued compliance, follow the attached installation instructions and use only shielded interface cables with ferrite core when connecting to computer or peripheral devices.

Any changes or modifications not expressly approved by the party responsible for compliance could void the user's authority to operate this equipment.

Trade Name: Panasonic
 Model No.: DMC-LC33
 Responsible party: Matsushita Electric Corporation of America One
 Panasonic Way,
 Secaucus, NJ
 07094
 Support Contact: Panasonic
 Consumer
 Electronics
 Company
 1-800-272-7033

This device complies with Part 15 of the FCC Rules. Operation is subject to the following two conditions: (1) This device may not cause harmful interference, and (2) this device must accept any interference received, including interference that may cause undesired operation.

This Class B digital apparatus complies with Canadian ICES-003

Panasonic DMC-LC33



Tested To Comply
 With FCC Standards

FOR HOME OR OFFICE USE

Extremely high precision technology is employed to produce the LCD Monitor screen featuring a total of approximately 114,000 pixels. The result is more than 99.99% effective pixels with a mere 0.01% of the pixels inactive or always lit. However, this is not a malfunction and does not affect the recorded picture.

Contents

Safety

Information for Your Safety 2

Preparation

Standard Accessories 5

Names of the Components 6

LCD Monitor Display 8

Quick Guide 10

Inserting the Batteries 11

Inserting the Card 16

Turning Power on/off..... 18

Attaching the Strap 19

Using the LCD Monitor..... 20

Using the Optical Viewfinder..... 21

The Shutter Button

(Pressing halfway/Pressing fully)... 21

The Mode Dial..... 22

Operating the Menu 23

Setting the Date/Time (Clock Set) ... 24

Recording images (basic)

Taking Pictures 25

Taking Pictures in Simple Mode 27

Checking the Captured Picture

(Review) 28

Recording Motion Images 29

Using the Optical Zoom 30

Using the Digital Zoom..... 31

Taking Pictures using the

Built-in Flash..... 32

Taking Pictures with the

Self-timer 34

Recording images (advanced)

Taking Pictures with Audio..... 35

Changing the Picture Size 36

Changing the Quality

(Data Compression Ratio) 37

Taking Pictures using

Macro Mode..... 38

Taking Pictures using

Portrait Mode 39

Taking Pictures using

Landscape Mode 40

Taking Pictures using

Night Portrait Mode..... 41

Using the Color Effect Mode 42

Taking Pictures using

Spot Mode 43

Compensating the Exposure..... 44

Taking Pictures using Auto

Exposure (AE) Bracket 45

Using the AF/AE Lock 46

Adjusting the Color Tone or the

Contrast (Picture Adjustment)..... 47

Setting the White Balance..... 48

Setting ISO Sensitivity..... 50

Taking Pictures using

Burst Mode 51

Playback

Playing Back Still Pictures..... 52

Playing Back Still Pictures

with Audio 53

9 Images Multi Playback 54

Using the Playback Zoom 55

Playing Back Motion Images..... 56

Editing

Deleting Images 57

Writing the Print Information to

the Card (DPOF Setting) 60

Protecting Images on the Card 63

Technical use

Playing Back with Slide Show

(Automatic Playback)..... 64

Adding Audio to Recorded

Pictures (Audio Dubbing)..... 66

Resizing Recorded Pictures..... 67

Trimming Recorded Pictures..... 68

Formatting the Card 70

Adjusting the LCD Monitor

Brightness..... 71

Using the Auto Review 72

Setting up the Operational Sound 73

Setting up the Power Save Mode..... 74

Saving the Power Consumption (Economy mode)	75	Message Indications	91
Resetting the File Number	76	Troubleshooting	92
Initializing the settings	77	Specifications	93
Playing Back Images with a TV Monitor	78	Digital Camera Accessory System	95
Connecting to a PC	79	Digital Camera Accessory Order Form	96
USB DIRECT-PRINT	80	Request for Service Notice (For USA Only)	97
USB DIRECT-PRINT (Single Picture)	81	Limited Warranty (For USA Only)	98
USB DIRECT-PRINT (DPOF)	82	Customer Services Directory (For USA Only)	100
Using the Optional AC Adaptor	83	Index	101
After Use	84	Spanish Quick Use Guide/Guía española para el uso rápido	102
Others			
The Menu Items	85		
Cautions for Use	87		

Standard Accessories

Before using your camera, check the contents.

- | | |
|--|--|
| 1 SD Memory Card (16MB)
RP-SD016B
(In the text, it is indicated as "Card") | 4 USB Connection Cable
K2KZ4CB00005 |
|--|--|

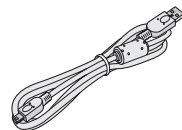
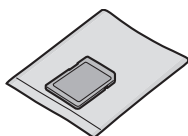

- | | |
|-----------------------------|---------------------|
| 2 AA Alkaline Dry Batteries | 5 CD-ROM
VFF0183 |
|-----------------------------|---------------------|



- | | |
|-----------------------------|--------------------|
| 3 A/V Cable
K2KD3CB00001 | 6 Strap
VFC3994 |
|-----------------------------|--------------------|

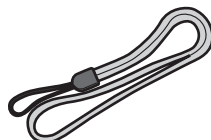

Names of the Components

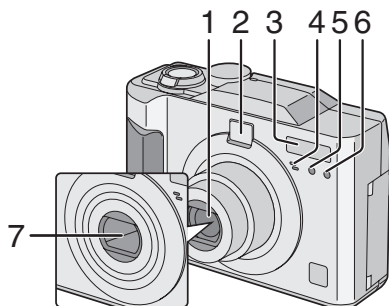

[Front View]

- 1 Lens
- 2 Optical Finder (P25)
- 3 Flash
- 4 Microphone (P29, P35, P66)
- 5 Flash Sensor (P33)
- 6 Self-timer Indicator (P34)
- 7 Lens Cover

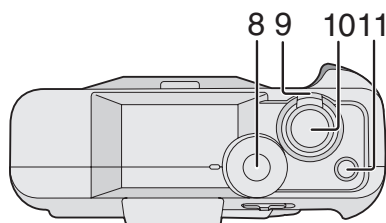

[Top View]

- 8 Mode Dial (P22)
- 9 Zoom Lever (P30, P31)
- 10 Shutter Button (P21)
- 11 Single/Burst Mode Button (P51)

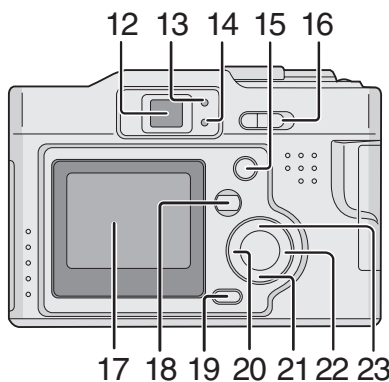

[Back View]

- 12 Optical Finder (P25)
 - 13 Status Indicator (P18)
 - 14 Flash/Access Indicator (P18)
 - 15 DISPLAY Button (P20)
 - 16 Power Switch (P18)
 - 17 LCD Monitor (P8, P25)
 - 18 MENU Button (P23)
 - 19 Delete Button (P28, P57)
 - 20 ◀/Self-timer Button (P34)
 - 21 ▼/REVIEW/SET Button (P28)
 - 22 ▶/Flash Mode Button (P32)
 - 23 ▲/Exposure Compensation Button (P44)
- /Auto Bracket Button (P45)

[Left View]

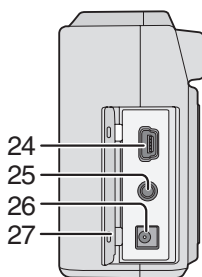

- 24 USB Socket (5pin) (P79)
- 25 A/V OUT Socket (P78)
- 26 DC IN Socket (P83)
- 27 Terminal Door (P83)

[Right View]

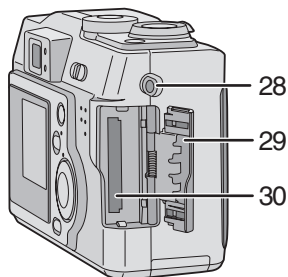

- 28 Strap Eyelet (P19)
- 29 Memory Card Door (P16)
- 30 Memory Card Slot (P16)

[Bottom View]

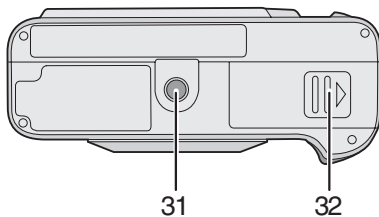

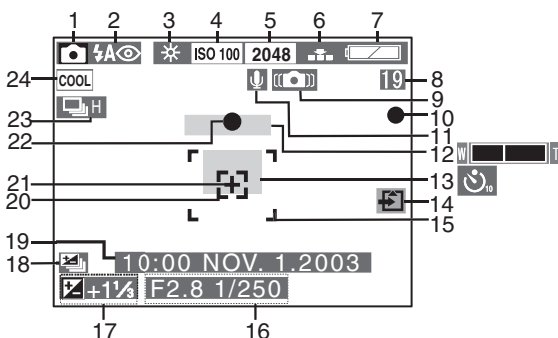

- 31 Tripod Receptacle
- 32 Battery Door (P11)

LCD Monitor Display



[In recording]

- | | |
|--|--|
| <p>1 REC mode (P22)</p> <p>2 Flash mode (P32)</p> <p>3 White balance (P48)</p> <p>4 ISO sensitivity (P50)</p> <p>5 Picture size (P36)</p> <p>6 Quality (data compression ratio) (P37)</p> <p>7 Battery indicator (P14)</p> <p>8 Frame/Time remain
In motion image mode: XXX S</p> <p>9 Camera shake alert (P26)</p> <p>10 Recording indication</p> <p>11 Audio REC (P35)</p> <p>12 Zoom (P30, P31)
(digital zoom ON: )</p> <p>13 Self-timer mode (P34)</p> <p>14 Card access indication (P17)</p> <p>15 AF area (P25)</p> <p>16 Aperture indication/Shutter speed
indication (P25)</p> <p>17 Exposure compensation (P44)</p> <p>18 Auto bracket (P45)</p> | <p>19 Current date and time (P24)</p> <ul style="list-style-type: none"> • It is displayed for about 5 seconds after turning on the power or setting the clock. <p>20 : Spot AF area (P43)</p> <p>21 : Spot metering target (P43)</p> <p>22 Focus indication (P25)</p> <p>23 Burst mode (P51)</p> <p>24 Color Effect mode (P42)</p> |
|--|--|

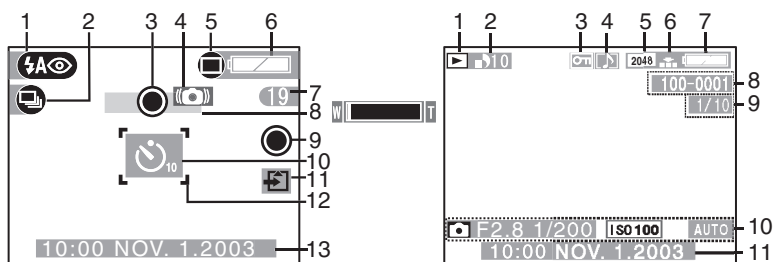

[In Simple Mode recording]

- 1 Flash mode (P32)
- 2 Burst mode (P51)
- 3 Focus indication (P25)
- 4 Camera shake alert (P26)
- 5 Picture mode (P27)
- 6 Battery indicator (P14)
- 7 Frame/Time remain
- 8 Zoom (P30)
- 9 Recording indication
- 10 Self-timer mode (P34)
- 11 Card access indication (P17)
- 12 AF area (P25)
- 13 Current date and time (P24)
 - It is displayed for about 5 seconds after turning on the power or setting the clock.

[In playback]

- 1 Playback mode
- 2 DPOF (P60)
 - (White): DPOF setting for printing
 - (Green): DPOF setting for Slide Show
 - (Green with DPOF number): DPOF setting for printing and Slide Show
- 3 Protected image (P63)
- 4 Image with audio (P66)
- 5 Picture size (P36)
- 6 Quality (data compression ratio) (P37)
 - : In motion image mode
 - In simple mode:
 - : ENLARGE
 - : 4"×6"/10×15cm
 - : INTERNET
- 7 Battery indicator (P14)
- 8 Folder/File number
- 9 Page/Total images
- 10 REC data
 - It will be displayed when the [DISPLAY] button is pressed.
- 11 Recorded date and time

Quick Guide

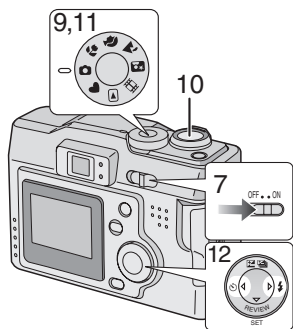
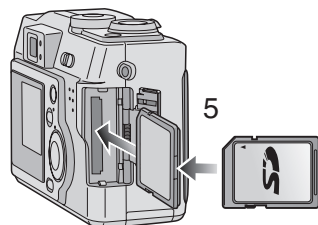
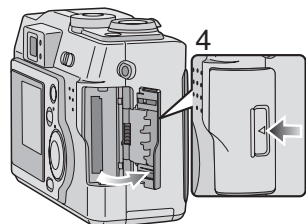
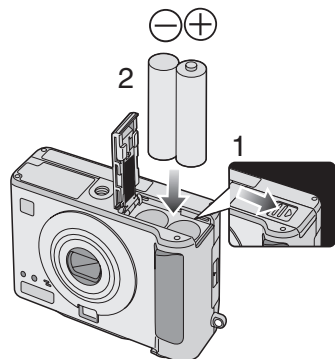

Prepare the following items.

- Camera
- Batteries
- Card

- Check that the power switch is set to [OFF] and the lens is stored.

[Preparation]

- 1 Slide the door to the direction of the arrow to open the battery door.
- 2 Insert the batteries into the camera. (P11)
 - Insert batteries observing the direction of the ⊕ and ⊖ polarities.
- 3 Close the battery door.
- 4 Slide the door to the direction of the arrow to open the Memory Card door.
- 5 Insert the Card into the camera. (P16)
- 6 Close the Memory Card door.

[Recording]

- 7 Set the power switch to [ON]. (P18)
- 8 Set date/time. (P24)
- 9 Set the mode dial to Normal picture mode [📷]. (P22)
- 10 Take a picture.

[Playback]

- 11 Set the mode dial to playback [▶].
- 12 Press ◀/▶ to select the picture you want to view. (P52)

Inserting the Batteries

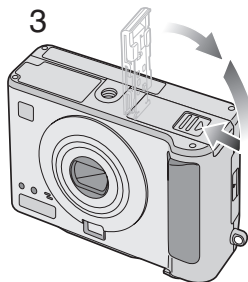
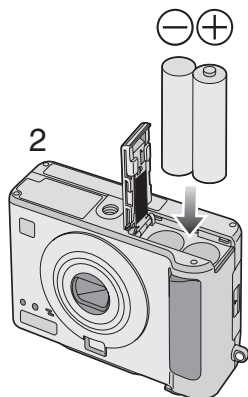
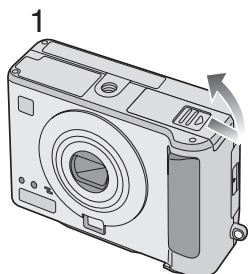

[Preparation]

- Check that the power switch is set to [OFF] and the lens is stored.

1 Slide the door in the direction of the arrow to open the battery door .

2 Insert the batteries.

- Insert the new batteries.
- Insert batteries observing the direction of the ⊕ and ⊖ polarities.

3 Slide the door to the direction of the arrow to close the battery door.

- Do not peel off the protective sticker ①.

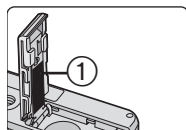

- When the new batteries are inserted in the camera for more than 3 hours, the clock setting is memorized by the camera for about 3 months even after the batteries are removed. (The time may be shorter if the batteries are not charged sufficiently) When the clock setting is cancelled, please set the date/time again. (P24)
- When the card is being accessed, do not remove the batteries.

CAUTION

Danger of explosion if battery is incorrectly replaced. Replace only with the same or equivalent type recommended by the manufacturer. Dispose of used batteries according to the manufacturer's instructions.

■ Recommended batteries

Use AA Alkaline batteries or AA Ni-MH (nickel-metal hydride) batteries (Optional). (We recommend that you use Panasonic batteries)

- The performance of the batteries may vary depending on brand or storage terms/condition of the battery. And it may cause malfunction or the available recording time may become shorter.
- As the ambient temperature decreases, the battery performance and capacity may temporarily decrease. In such cases, remove the batteries, warming them in your pocket.
- The battery indicator may not be displayed correctly depending on the temperature or other conditions. Battery may be empty without indication.

Batteries that should not be used

Manganese batteries	Nickel batteries
Ni-cd batteries	Lithium batteries

- If the batteries listed above are used, improper operation can result and the following malfunctions can occur;
 - Remaining battery time may not be displayed accurately.
 - Camera may turn off prematurely.
 - Data written to Memory Card can be damaged resulting in the loss of photos.

Nickel Manganese batteries

- If Nickel Manganese batteries are used, due to temperature variations, the battery display may not accurately display the remaining battery life. The camera may prematurely turn off even if there is sufficient battery life. The available time becomes extremely short in cold places, so use them after warming them in your pocket.

■ Batteries that cannot be used

The following batteries cannot be used.

- Batteries where part or their entire outer covering jacket has been removed or partially peeled away.
- Batteries that have “flattened” ends that would prevent a proper connection from being made with internal battery contacts.

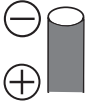
<ul style="list-style-type: none"> • All or part of the seal of batteries are peeled off 	<ul style="list-style-type: none"> • ⊖ polarity is flat 
---	--

■ Proper Care and Handling of the Batteries

If you mishandle the batteries, leakage, generation of heat and fire or explosion may occur. Observe the following cautions;

- Do not attempt to disassemble the battery or subject the battery to any extreme mechanical abuse.
- Do not heat or throw into the fire.
- Do not allow the battery contacts to touch metal objects.
- Do not subject the battery, battery connectors, or the camera to any direct moisture, especially salt water. This can cause corrosion of the metal surfaces.
- Do not peel off or remove the outer battery covering.
- Do not throw the batteries.
- Do not use batteries that appear mechanically damaged, swollen or show signs of leakage.
- Do not store batteries in high humidity or high temperature environments.
- Keep batteries away from small children.
- Do not install batteries backwards (reverse polarity). Serious damage or injury can result.
- Do not mix new batteries and old batteries.
- All batteries should be of the same brand, size, capacity. Avoid mixing batteries.
- If you will not be using the camera for a long time, remove the batteries.
- Following prolonged use, it is normal for the battery to be warm.
- As the ambient temperature decreases, the battery capacity and performance will decrease. This is normal. In such cases, remove the batteries and warm them in your pocket. Take special care not to allow the contacts to come into contact with metal objects in your pocket.
- If oxidation or any foreign substance is found on the battery contacts it could prevent the battery from making a good electrical contact. Operation could become intermittent. If this occurs, clean the battery contact with an ink eraser.

If any leakage from the battery is noted, avoid direct skin contact. Remove the battery and clean as much of the foreign substance as possible. Contact your local service center for assistance if necessary.

■ Optional Ni-MH Battery (Nickel Metal Hydride)

The battery charger should only be used with the optional Ni-MH batteries. Do not attempt to charge non-rechargeable batteries.

Please be aware of the following issues;

- If any oxidation or foreign substance is found on the battery contacts, the battery may not be charged correctly. Battery contacts can be cleaned with a soft cloth or ink eraser.
- Newly purchased rechargeable batteries or those which have not been used for a long period of time may not reach full capacity after one charge. The overall performance will increase after 2-3 discharge/charge cycles.
- Rechargeable batteries should be used to the point when the camera stops working. They should be recharged as soon as possible. Premature charging can cause “memory effect”, whereby the overall operating time can be decreased.
- Even during storage, rechargeable batteries will naturally discharge. We suggest charging before each use.
- Once batteries have reach full charge, avoid over charging them.
- Do not peel off or damage the covered seal.
- Read the Operating Instructions for the battery charger.

Ni-MH batteries have a limited life. The battery power decreases gradually over time. If available time seems much shorter, purchase the new batteries.

- The battery’s life differs depending on the condition stored or used or environment.

■ Battery indicator

The remaining battery power is displayed on the LCD monitor. (This is not displayed when using AC adaptor (optional, DMW-AC1).)



: The battery power is sufficient



: The remaining power is low



: There is little remaining power



(blink): Replace the batteries

- The battery indicator may not be displayed correctly depending on the temperature or other conditions. As a result, even if the battery indicator is not empty, the power may be turned off. This is not a malfunction.
- Even if the battery power depletes when leaving them unused for a while, the battery power may recover. However, they will not be usable, so replace them to new ones once the battery power depletes.

■ Available recording/playback time

Measured under the following conditions:

- Shooting once every 30 seconds, flash every other shot.
- Measured using supplied SD Memory Card.
- Temperature: 77 F (25°C)/Humidity: 60%

Batteries	Continuous recording/playback time (recordable number)
Supplied batteries or Panasonic Alkaline batteries	Recording with LCD monitor on Approx. 75 min. (equal to 150 still pictures)
	Recording with LCD monitor off Approx. 5 h. (equal to 600 still pictures)
	Playback time Approx. 3 h.
Fully charged Panasonic Ni-MH (nickel-metal hydride) batteries (Optional: HHR-3EPA)	Recording with LCD monitor on Approx. 120 min. (equal to 240 still pictures)
	Recording with LCD monitor off Approx. 6 h. (equal to 720 still pictures)
	Playback time Approx. 4 h.

- The times shown in the table are approximate times. The times may vary depending on the condition.
- Available recording/playback time varies depending on the batteries used.

Inserting the Card

[Preparation]

- Check that the power switch is set to [OFF] and the lens is stored.

[Inserting the card]

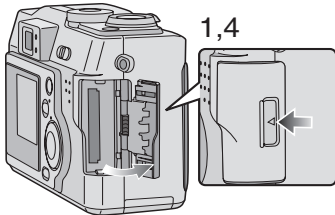

- 1 Slide the door in the direction of the arrow to open the Memory Card door.
- 2 Insert the card all the way in until it clicks.

- Check the direction of the card.
- Do not touch the connection terminals on the back side of the card.

- 3 Slide the door in the direction of the arrow to close the Memory Card door.

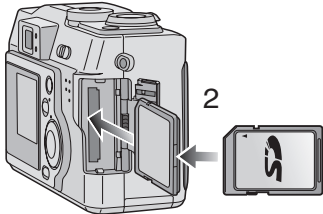

[Removing the card]

- 4 Slide in the direction of the arrow to open the Memory Card door.
- 5 Press the card to release.
- 6 Pull the card out.
- 7 Slide the door in the direction of the arrow to close the Memory Card door.

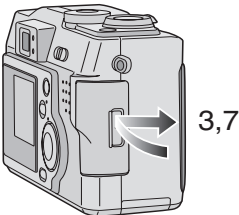

- If you are using a MultiMediaCard type memory card and the Memory Card door cannot close, the card may be installed backwards. Remove the card and reverse it, then try to close the door again.
- If the Memory Card door cannot be completely closed, take the card out and insert it again.
- We recommend that you use a Panasonic branded SD Memory Card. (Use only the genuine card)
- If the card is not fully inserted, the card may be damaged.

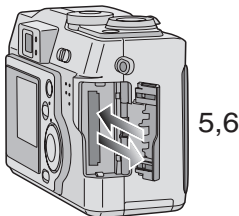

Access to the card

When the card is being accessed, the flash/access indicator ① and card access indication ② lights.

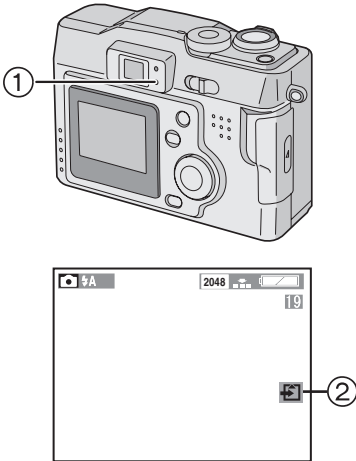

When the flash/access indicator ① and the card access indication ② lights;

- Do not turn off the camera.
- Do not remove the batteries or pull out the card.
- Do not remove the AC adaptor (optional, DMW-AC1)

The card and the card contents may be destroyed and the camera may not operate normally.

As there is a risk that the data on the card may be damaged or erased due to electrical noise, static electricity or the defects of camera/card, please back up your data on your PC using USB connection. (P79)

SD Memory Card (supplied) and MultiMediaCard (optional)

The SD Memory Card and MultiMediaCard are small, lightweight, removable external cards. The reading/writing speed of SD Memory Card is fast. The SD Memory Card is equipped with a write protection switch that can inhibit writing and formatting. (When the switch is moved towards the [LOCK] side, it is not possible to write or delete data on the card and format it. When the switch is unlocked, these functions become available)

SD Memory Card



MultiMediaCard

- The reading/writing speed of MultiMediaCards is slower than SD cards. When MultiMediaCards are used, the performance of certain features may be slightly slower than advertised.
- After recording motion images using the MultiMediaCard, the flash/access indication and the card access indication may appear for a while, but this is not a malfunction.
- Keep the Memory Card out of reach of children to prevent swallowing.



Turning Power on/off

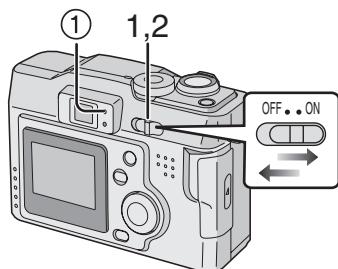

- 1 **Set the power switch to [ON].**
 - The Status indicator ① lights.
- 2 **Set the power switch to [OFF].**

- When the power switch is turned on, do not hold the lens cover. If the lens cover does not open, [SYSTEM ERROR] is displayed. Turn the power switch off and on.
- Do not apply pressure to the lens when the lens tube comes out.

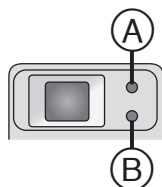

■ Status Indicator ①

Lights:

- When turning the Power switch to [ON].

Blinks:

- While the focus is being adjusted or the focus is not properly adjusted.
- When the card is not inserted.
- When no space is left on the card.
- When the remaining battery power is low. (blinks slowly)

■ Flash/Access Indicator ②

Lights:

- When accessing the card.
- When the flash fires. (It lights when the shutter is pressed halfway)
- When sending data to PC.

Blinks:

- When charging the flash.
- When setting the flash mode to forced off and recording in dark places. (blinks slowly)

Attaching the Strap

1

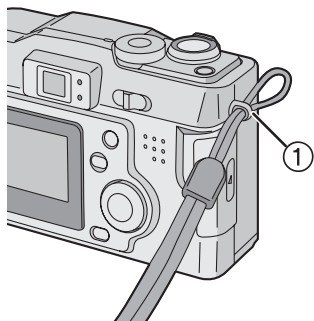

1 Pass the top of the strap through the strap eyelet ①.

2 Pass the opposite side of the strap through its ring shaped part.

3 Pull the strap.

2

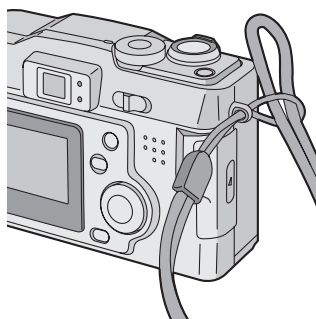

3

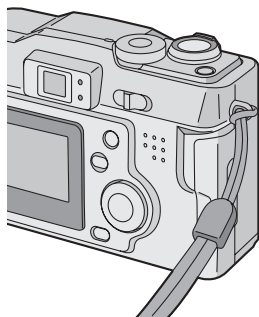

Using the LCD Monitor

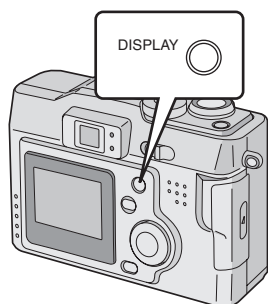

Every time you press the [DISPLAY] button, the display of the LCD monitor changes as shown below.

[In recording]

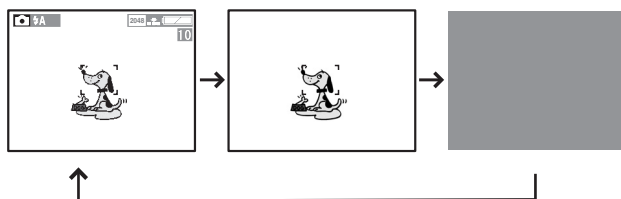

[In playback]

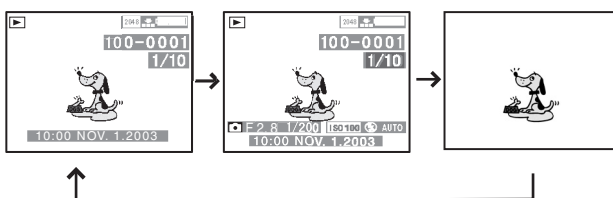

Using the Optical Viewfinder

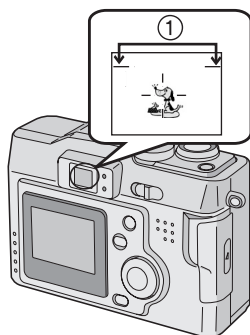

Parallax compensation mark

- If you take a picture of a subject at a distance between 2.3 feet (70 cm) and 3.94 feet (120 cm) with the zoom in tele position, match the top of the subject with the parallax compensation mark ①. When accurate framing is necessary, use the LCD monitor.

The Shutter Button (Pressing halfway/Pressing fully)

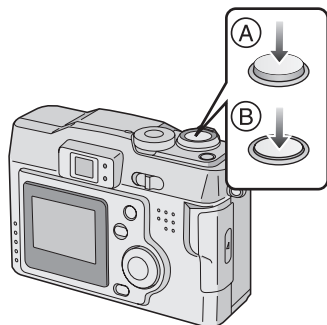

The shutter button is activated in 2 steps: “pressing halfway” and “pressing fully”.

Pressing halfway ①

- Focus and exposure are locked.

Pressing fully ②

- The picture is captured. In motion image mode, the recording starts.

- You can adjust volume of the operational sound in the menu. (P73)
- If you press the shutter button fully in a single stroke, the captured picture may appear shaken or unfocused. (The camera may have moved during capturing)

The Mode Dial

You can choose a desired mode by the mode dial.

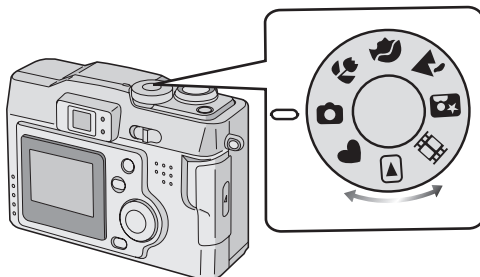

 : Playback (P52)

Playback recorded images.

 : Simple mode (P27)

Menu options are minimized and many settings are preset. This is a fast and easy way for beginners to start using the camera and become familiar with its many features.

 : Normal Picture (P25)

The shutter speed and the aperture value are automatically adjusted.

 : Macro mode (P38)

When you take pictures from a distance closer than 1.64 feet (50 cm), set the camera in macro mode. This allows you to get closer to the subject up to 1.64 feet (50 cm) (Tele), 0.33 feet (10 cm) (Wide).

 : Portrait mode (P39)

This mode allows you to easily achieve the depth of focus effect. The subject stands out in front of an unfocused background.

 : Landscape mode (P40)

You can capture sharp and crisp landscape photos easily. Please note that this mode is suitable for landscape farther than 32.8 feet (10 m) away and in daylight.

 : Night portrait mode (P41)

When you take pictures of, for example, your friends in front of beautiful night illumination scenery, this mode allows you to get the appropriate exposure for your subject as well as the background, using flash and slow shutter.

 : Motion images mode (P29)

Use this mode when recording motion images.

Operating the Menu

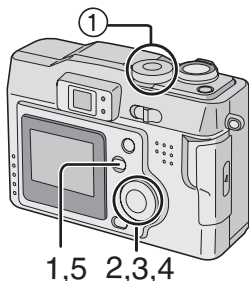

The camera menu allows you to configure the Record and Playback modes, date and time, and various other operational sounds the camera produces. Follow these instructions.

[Preparation]

- Set the mode dial to the recording mode (except for [♥]) or the playback mode.

1 Press the [MENU] button.

- If you set the mode dial ① to the recording mode, the REC menu is displayed; if you set it to the playback mode, the playback menu is displayed.

2 Press ►.

3 Press ▲/▼ to choose the item.

4 Press ◀/▶ to set the item.

5 Press the [MENU] button.

- The menu will disappear.

1

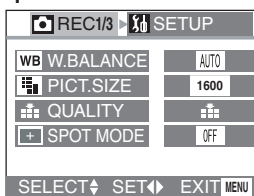

2

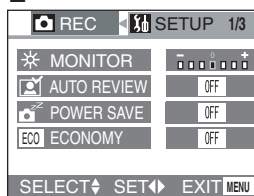

3

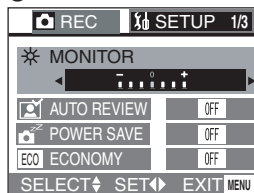

4

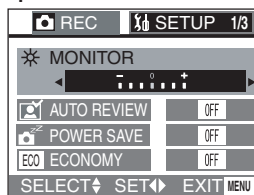

Setting the Date/Time (Clock Set)

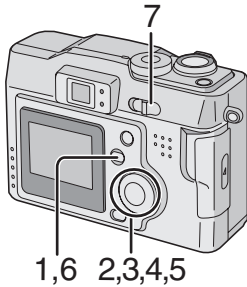

3

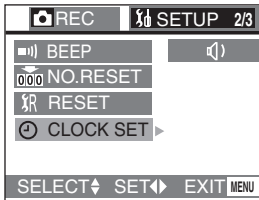

4,5

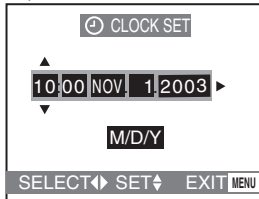

If the message [PLEASE SET THE CLOCK] appears, set the date and time. You can go to the setup menu by pressing the [MENU] button while the message is displayed. You can set the year from 2003 to 2099. The 24-hour system is used.

- 1 Press the [MENU] button.
- 2 Press ► to make the setup menu appear.
 - In simple mode, skip this step.
- 3 Press ▲/▼ to select [CLOCK SET], and then press ►.
- 4 Press ▲/▼/◀/▶ to set date and time, and then press ►.
- 5 Press ▲/▼ to select [M/D/Y], [D/M/Y] or [Y/M/D].
- 6 Press the [MENU] button 2 times.
 - The menu will disappear.
- 7 Check if the date/time setting is displayed correctly, after turning the camera [OFF] and [ON].
 - When the new batteries are inserted in the camera for more than 3 hours, the time and date will be held for approximately 3 months if the battery is removed. If the batteries were not new, the time may not be retained properly. If the time/date setting is lost please reset it.

Taking Pictures

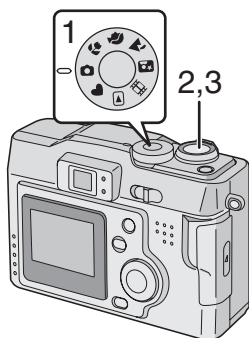

By only pressing the shutter button, the exposure (shutter speed and aperture value) will be automatically adjusted and the picture will be taken.

[Preparation]

- Insert the card. (P16)
- Set the power switch to [ON]. (P18)

1 Set the mode dial to normal picture mode [📷].

2 [A Optical finder]

Center the subject in the AF target ① inside the optical finder and press the shutter button halfway.

[B LCD monitor]

After centering the subject in the AF area ② on the LCD monitor, press the shutter button halfway.

- When the focus is adjusted, the focus indication [●] ③ appears.
- When the focus indication flashes, the focus is not adjusted. Press the shutter button halfway to adjust the focus again.
- The shutter speed and the aperture value ④ are automatically adjusted and displayed on the LCD monitor.
- When the subject is out of the AF area, use the AF/AE lock. (P46)

3 Press the shutter button fully to take the picture.

- After taking a picture, when the auto review (P72) is set to [1SEC.]/[3SEC.], the picture is displayed on the LCD monitor for 1 or 3 seconds.

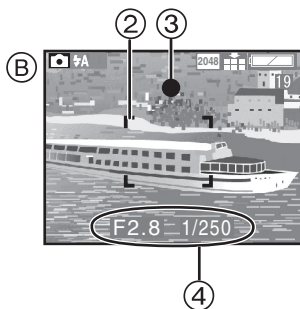
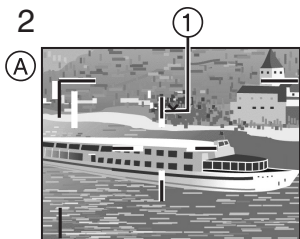

- If you do not press the shutter button halfway, camera shake may occur or focus may not be adjusted properly.
- Even when the focus indication is displayed and the focus is properly adjusted, it will be cancelled if you release the shutter button.
Press the button halfway again.
- When setting [ECONOMY] to [ON], if you do not operate the camera for approx. 15 seconds, the LCD monitor turns off. (If you press any button, the LCD monitor turns on)
- When power saving time is set, if you do not operate the camera for a while, it is automatically turned off at the set time. To operate the camera again, press the shutter button or turn the power switch first to [OFF] and then to [ON]. (P74)
- The brightness of the LCD monitor may differ from that of the recorded pictures. In particular, when taking pictures in dark places with a long exposure time, darkness appears on the LCD monitor, but the recorded pictures are bright.
- If the exposure is not properly set, the color of the aperture value and the shutter speed on the LCD monitor becomes red.
- In the following cases, the focus may not be adjusted properly.
 - 1 Recording a scene including subjects both near and far
 - 2 Recording a scene through a dirty lens
 - 3 Recording an illuminated subject
 - 4 Recording in a dark place
 - 5 Recording a moving subject
 - 6 Recording a subject with a little contrast
 - 7 Recording with camera shake
- We recommend that you set the clock setting again before taking pictures.
- When the brightness of the LCD monitor changes, such as while zooming or panning, you may hear a click sound from the lens or the image on the LCD monitor may change suddenly; this is not a malfunction. The sound is caused by the camera automatically adjusting the aperture value.
- When pressing the shutter button in low light/dark conditions, the LCD monitor display may become bright or whitish. However, the recorded picture will not be influenced. This function makes it easy to adjust the focus.

About camera shake

- Be careful to prevent camera shake when you press the shutter button.
- We recommend you use a tripod when the camera shake alert ① appears.

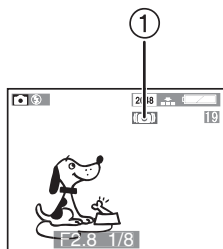

Taking Pictures in Simple Mode

- Offers simplified menu for ease of use.
- The picture size is easy to select.
- The icons on the display are larger.

We recommend you use this mode when you ask someone to take a picture.

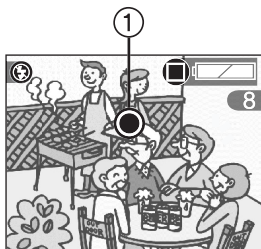
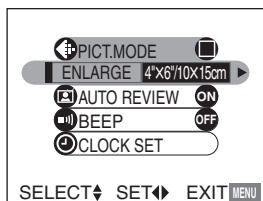
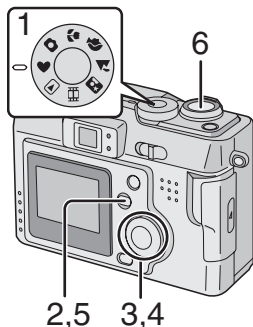

- 1 Set the mode dial to Simple mode [♥].
- 2 Press the [MENU] button.
- 3 Press ▲/▼ to select [PICT.MODE].
 - [AUTO REVIEW] (P72)
 - [BEEP] (P73)
 - [CLOCK SET] (P24)
- 4 Press ◀/▶ to select [ENLARGE], [4"×6"/10×15cm], [INTERNET].

ENLARGE	2048×1536	Fine
4"×6"/10×15cm	1280×960	Fine
INTERNET	640×480	Standard

- [ENLARGE] Selection is intended for situations when large printing is desired. The camera is preset to [2048×1536] in [Fine] picture mode.
- [4"×6"/10×15cm] Selection will offer an easy way to produce small "general purpose" prints.
- [INTERNET] Selection favors smaller file size, optimized for home page and e-mail use.

- 5 Press the [MENU] button.
- 6 Take a picture.

- The burst mode is available only with the low speed. (P51)
- If the distance between the camera and the object is beyond the recordable range (Tele: 1.64 feet (50 cm) - ∞, Wide: 0.33 feet (10 cm) - ∞), the focus may not be adjusted properly even if the focus indication ① is lit.
- The settings (except for the clock setting) of the simple mode will not be applied to the other recording modes.
- Burst mode will not operate as described if a MultiMediaCard type Memory Card is used.
- Only the quality (data compression ratio) cannot be changed on the [PICT.MODE] menu.

Checking the Captured Picture (Review)

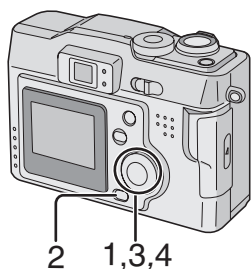

After taking a picture, the Auto review (P72) feature will cause the captured picture to be displayed on the LCD monitor for the designated time - 1 or 3 seconds. You may also check the picture using the method described below.

1 After taking a picture, press the \blacktriangledown /[REVIEW/SET] button.

- The last captured picture is displayed for about 5 seconds. If you rotate the zoom lever towards [Q], the captured picture is zoomed 4 times (A) and 8 times if you rotate it once again. You can also change the position with \blacktriangle / \blacktriangledown / \blacktriangleleft / \blacktriangleright .
- You can check the previous or following picture with \blacktriangleleft / \blacktriangleright .

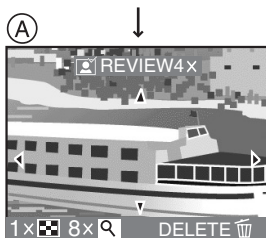
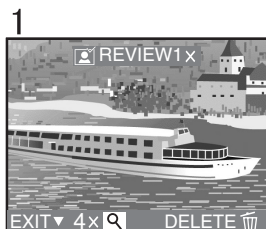

Erasing the captured picture during the review

2 Press [DELETE].

3 When the message [DELETE THIS PICTURE?] is displayed, press \blacktriangleleft to select [YES].

4 Press the \blacktriangledown /[REVIEW/SET] button.

- The picture is erased.
- Once erased, pictures cannot be recovered.
- Multi images or all images can be deleted. Read pages 58, 59 to operate them.



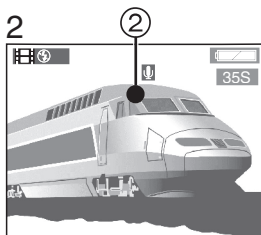
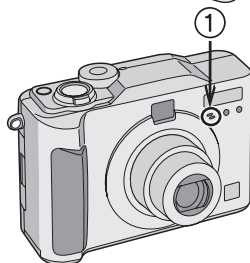
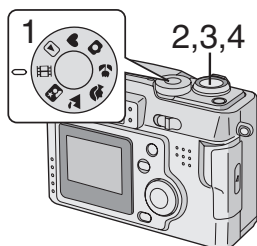

- Press the shutter button halfway to cancel the review.
- In motion image mode [H], Review feature cannot be used.

Recording Motion Images



With this camera you can also record motion images. (If using the supplied 16MB SD Memory Card, it is possible to record for up to about 80 seconds)

- 1 **Set the mode dial to motion image mode [].**
- 2 **Center the subject on the LCD monitor and press the shutter button halfway.**
 - When the focus is adjusted, the focus indication ② [] appears.
- 3 **By pressing the shutter button fully, the recording starts.**
 - The audio REC starts simultaneously. (① Microphone)
- 4 **By pressing the shutter button fully again, recording stops.**
 - If during the recording the memory of the card becomes full, the recording is stopped automatically.

- **Audio cannot be played back from this camera. Connect to a television or PC to play back audio.**
- The picture size is fixed to 320×240 pixels.
- The remaining time displayed on the LCD monitor is an approximation.
- You cannot record motion images without audio.
- If using the MultiMediaCard, after recording motion images, the card access indication and the flash/access indicator may appear for a while, but this is not a malfunction.
- After recording starts, the auto focus/zoom/white balance/aperture values are locked (with the first frame).
- Recording could suddenly stop when recording motion images with cards other than a Panasonic SD Memory Card.
- When the motion image recorded with this camera is played back on other equipment, the quality of pictures and sounds may be deteriorated or pictures may not be able to be played back.
- In motion image mode [], review cannot be used.

Using the Optical Zoom

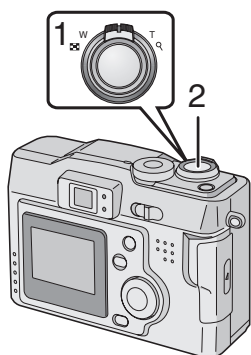

The Optical Zoom allows you to bring your subject up to 3 times closer. It also allows you to zoom back so that landscape scenes can be photographed at a wide angle.

[Preparation]

- Set the mode dial except for [▶]. (P22)

- 1 **Aim the camera at the subject and adjust the size with the zoom lever.**
To make subjects closer (Tele):
 Rotate towards T.
To make subjects wider (Wide angle):
 Rotate towards W.
- 2 **Take a picture.**

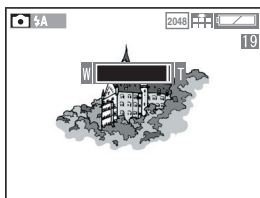
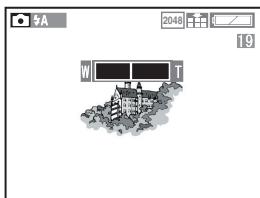
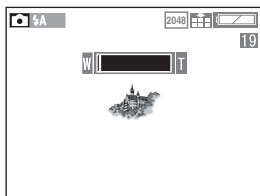

- The focus is adjusted at a distance of more than 1.64 feet (50 cm). For details on macro mode/simple mode, read pages 27, 38.
- The picture may be slightly distorted according to the lens. The distortion will increase as you make subjects wider and closer.

Using the Digital Zoom

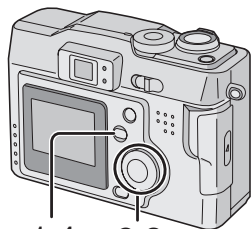

1,4 2,3

2,3

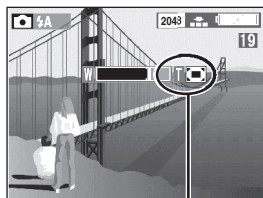
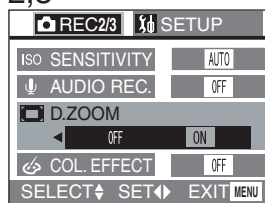

①

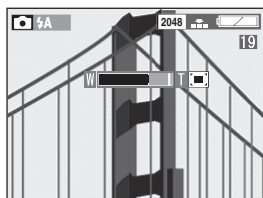

The Digital Zoom feature allows you to bring the subject an additional 3 times closer, thereby achieving an overall effective 9× zoom. In some cases the use of Digital Zoom can cause a slight deterioration of picture quality.

[Preparation]

- Set the mode dial except for []/[]. (P22)

- 1 Press the [MENU] button.
- 2 Press ▲/▼ to select [D.ZOOM].
- 3 Press ◀/▶ to set to [ON].
- 4 Press the [MENU] button.

- The menu will disappear.

- The zoom adjustment and recording method are the same as in “Using the Optical Zoom”. (P30)
- When the digital zoom is set to [ON], the digital zoom indication ① appears.
- When entering the digital zoom range, the zoom bar will pause.
- The digital zoom is cancelled when the LCD monitor turns off.
- When using digital zoom, it is normal to see a slight deterioration of the picture quality.
- We recommend that you use a tripod in the digital zoom range.

Taking Pictures using the Built-in Flash

[Preparation]

- Set the mode dial except for []/[]/[]. (P22)

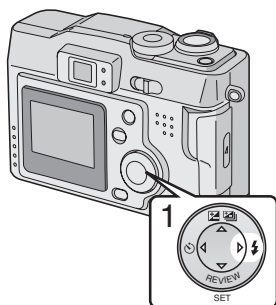

1 Press [].

- Every time you press [], the available settings will appear as shown below. (There are settings that cannot be set according to the REC mode. Those that cannot be set are not displayed when pressing []. Refer to the table on the left.)



	⚡A	⚡A👁	⚡	⚡S👁	👁
📷	○	○	○	○	○
❤	-	○	○	-	○
🌸	○	○	○	○	○
👋	○	○	○	-	○
🏔	-	-	-	-	○
📷❤	-	-	-	○	○
📷🌸	-	-	-	-	○

⚡A : AUTO

The flash fires automatically according to the lighting condition.

⚡A👁 : AUTO/Red-eye reduction

The flash fires automatically according to the recording situation.

It reduces the red-eye phenomenon (When a subject's eyes appear red in flash light). Use it when you take pictures of people or animals in low lighting conditions.

⚡ : Forced ON

The flash fires every time a picture is captured.

Use this setting when your subject is back-lit or under fluorescent light.

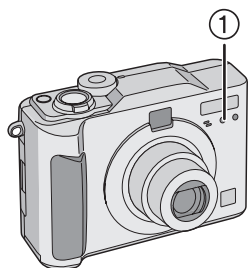
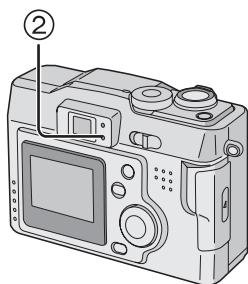





 : Slow sync./Red-eye reduction

When you take a picture with a dark background landscape, it makes the flash fire and the shutter speed slow, so that the dark background landscape will become bright. Simultaneously it reduces the red-eye phenomenon. We recommend that you use a tripod.

 : Forced OFF

Even in dark places, the flash does not fire. Set it when you take pictures in places where using flash is not allowed.

- Do not stare at the flash light from close proximity when using the flash.
- The available flash range is about 1.64 feet (50 cm) - 4.59 feet (140 cm)(Tele), 0.98 feet (30 cm) - 7.87 feet (2.4 m)(Wide).
- When the camera shake alert is displayed within the available flash range, we recommend using the flash.
- Do not cover the flash sensor ① with your fingers or other items. Otherwise, brightness cannot be perceived.
- In landscape mode []/motion image mode [], flash setting is fixed to the Forced OFF [].
- When you set to burst mode or auto bracket, only 1 picture is taken for every flash firing.
- The flash indication becomes red when pressing the shutter button halfway.
- When the flash/access indication ② and the flash indication blink red, you cannot take a picture even when you press the shutter button fully.
- If the battery indicator is less than  or setting [ECONOMY] to [ON], the LCD monitor turns off during charging the flash.
- When using the flash, do not let subjects get too close to the flash. The shape or color of subjects may be changed because of the heat and light of the flash.
- When taking a picture with the flash, the white balance will be automatically adjusted (for AUTO and Halogen mode), but the white balance may not be properly adjusted when the Photo Flash is insufficient.
- When taking a picture with the flash after setting the white balance manually, the white balance may not be properly adjusted. We recommend setting the white balance to [AUTO] when using the flash. (P48)

Taking Pictures with the Self-timer

Using the Self Timer feature, you can be part of the picture. The camera will automatically take a photo either 2 or 10 seconds after the shutter button is pressed.

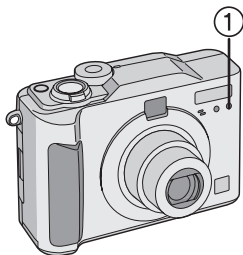

[Preparation]

- Set the mode dial except for [▶]/[📷]. (P22)

1 Press the [🕒] button.

- Every time you press it, the display changes as shown below.



: Self-timer set to 10 seconds

: Self-timer set to 2 seconds

When these indicators are not displayed, self-timer setting is cancelled.

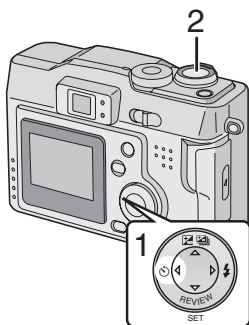

2 Press the shutter button fully.

- The self-timer indicator ① blinks and the shutter is activated after 10 seconds (or 2 seconds).
- When setting the self-timer, the focus and exposure are not adjusted by pressing the shutter button halfway. When pressing the button fully, they are automatically adjusted just before recording.
- If you press the [MENU] button when the self-timer is set, the self-timer setting is cancelled.



- In simple mode [♥], you can only set to 10 seconds [].
- In burst mode, the self-timer setting applies to the first picture only.
- We recommend you use a tripod when setting the self-timer.

Taking Pictures with Audio

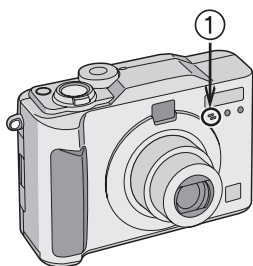
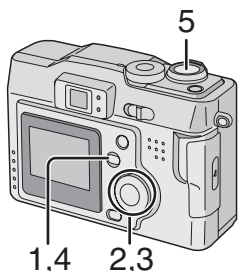

2,3

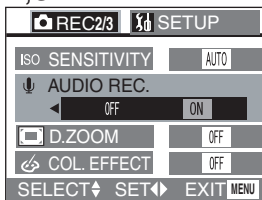

4



You can take a picture with audio for 5 seconds.

[Preparation]

- Set the mode dial except for [] [] [] []. (P22)

- 1 Press the [MENU] button.
- 2 Press ▲/▼ to select [AUDIO REC.].
- 3 Press ◀/▶ to set to [ON].
- 4 Press the [MENU] button.
 - The menu will disappear.
 - This icon [] will appear on the LCD monitor.
- 5 Press the shutter button fully and take a picture.
 - It is not necessary to continue pressing the shutter button.
 - Audio is recorded from the built-in microphone ① of the camera.
 - 5 seconds later, the audio recording is stopped automatically.
 - If you press the [MENU] button during the audio recording, it will be cancelled.

- **Audio cannot be played back from this camera. Connect to a television or PC to play back audio.**
- Using this feature will result in fewer images being able to be saved.
- When setting to burst mode/auto bracket, it is not possible to take a picture with audio. (P45, P51)
- The picture with audio cannot be resized or trimmed. (P67, P68)

Changing the Picture Size

You can choose among 4 picture size settings.

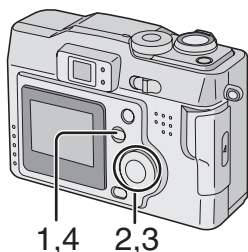

2,3

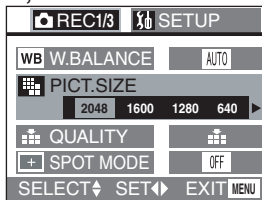

[Preparation]

- Set the mode dial except for []/[]/[]. (P22)

- 1 Press the [MENU] button.
- 2 Press ▲/▼ to select [PICT.SIZE].
- 3 Press ◀/▶ to select the picture size.

- [2048]: 2048×1536 pixels
- [1600]: 1600×1200 pixels
- [1280]: 1280×960 pixels
- [640]: 640×480 pixels

- 4 Press the [MENU] button.

- The menu will disappear.

- In motion image mode [], the picture size is fixed to 320×240 pixels.
- The smaller the picture size you select, the more pictures you can store on the Memory Card. In addition, a small data volume allows you attach the picture to an e-mail or post it on a website more easily. If you select a larger picture size, the printed picture will be clearer, especially with larger sized prints.

Changing the Quality (Data Compression Ratio)

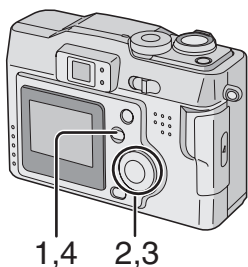

2,3

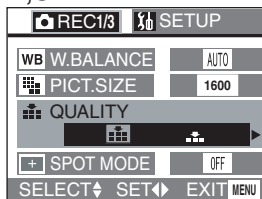

You can choose among 2 quality levels (Data Compression Ratio).

[Preparation]

- Set the mode dial except for

[▶]/[♥]/[H]. (P22)

- 1 Press the [MENU] button.
- 2 Press ▲/▼ to select [QUALITY].
- 3 Press ◀/▶ to select the quality (Data Compression Ratio).

- [FINE] : Fine (Low compression)
It gives priority to picture quality to record high quality pictures.
- [STANDARD] : Standard (Standard compression)
It gives priority to the number of recordable pictures and records standard quality pictures.

- 4 Press the [MENU] button.

- The menu will disappear.

- Picture size/Quality and number of recordable pictures (16MB/64MB SD Memory Card)

Picture size	16MB (supplied)		64MB (optional)	
	[FINE]	[STANDARD]	[FINE]	[STANDARD]
2048 × 1536	10	20	45	88
1600 × 1200	17	34	74	149
1280 × 960	22	43	96	184
640 × 480	69	129	298	553
In motion image mode	80 seconds		350 seconds	

- The numbers shown in the table are approximate numbers. The number of recordable pictures changes depending on the subject.
- It may happen that pictures appear like a mosaic depending on the scene characteristics.
- Remaining frame which is displayed on the LCD monitor may not correspond with recorded frames, however, this is not a malfunction.

Taking Pictures using Macro Mode

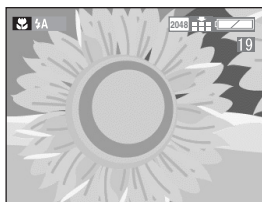
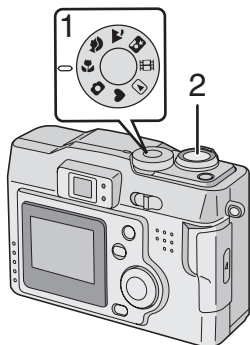

When you take pictures from a distance closer than 1.64 feet (50 cm)(Tele), set the camera in macro mode [🌸]. This allows you to get closer to the subject up to 0.33 feet (10 cm)(Wide).

- Macro Mode [🌸]

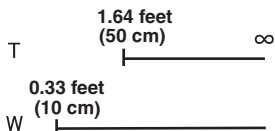

- Normal recording

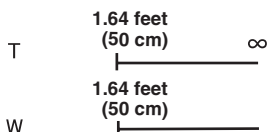

- 1 Set the mode dial to Macro mode [🌸].
- 2 Take a picture.

- Select the flash setting depending on the situation. (P32)
- The available flash range is about 1.64 feet (50 cm) - 4.59 feet (140 cm)(Tele), 0.98 feet (30 cm) - 7.87 feet (2.4 m)(Wide). (When setting to ISO100)
- When the camera shake alert is displayed within the available flash range, we recommend using the flash.
- When the camera lens is at a distance over the available range from the subject, focus may not be adjusted even if the focus indication appears.
- When selecting the macro mode, optical finder functionality is limited. Use the LCD monitor.

Taking Pictures using Portrait Mode

This mode allows you to easily achieve the depth of focus effect. The subject stands out in front of an unfocused background.

We recommend placing the subject much closer and allowing for proper distance between subject and background.

Please note that this mode is suitable for outdoor situations under sunlight.

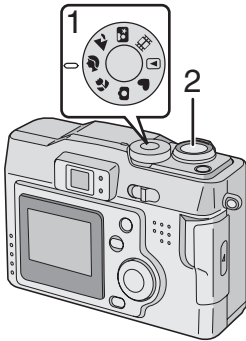

- 1 **Set the mode dial to Portrait mode [].**
- 2 **Take a picture.**



- [AUTO] setting in [W.BALANCE] works best when recording outdoors in the daytime. When using indoors, the color balance can change. You can change the white balance setting. (P48)

Taking Pictures using Landscape Mode

In Landscape mode the camera is adjusted to produce the greatest depth of field. This mode works best outdoors under direct sunlight at distances exceeding 32.8 feet (10 m).

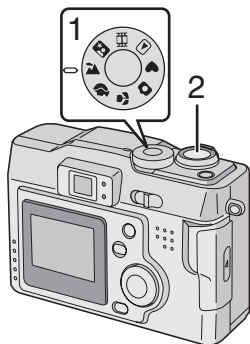

- 1 **Set the mode dial to Landscape mode** [L].
- 2 **Take a picture.**

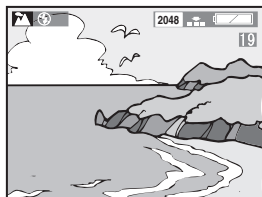

- Flash is set to Forced OFF [OFF].
- The focus is adjusted at a distance of 32.8 feet (10 m) - ∞ (Tele), 9.84 feet (3 m) - ∞ (Wide).
- [AUTO] setting in [W.BALANCE] works best when recording outdoors in the daytime. When using indoors, the color balance can change. You can change the white balance setting. (P48)

Taking Pictures using Night Portrait Mode

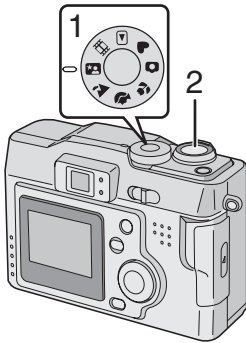

The Night Portrait mode combines the electronic flash with a “slow shutter” mode. This unique feature allows you to photograph close subjects against the natural night background. Since the shutter speed is slow, we highly recommend using a tripod to steady the camera.

The subject should be positioned within the available flash range. (Tele: 1.64 feet (50 cm) - 4.59 feet (140 cm), Wide: 0.98 feet (30 cm) - 7.87 feet (2.4 m).)

We recommend setting the zoom lever towards W.

- 1 **Set the mode dial to Night portrait mode [📷].**
- 2 **Take a picture.**

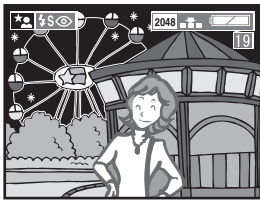

- When flash is set to Forced OFF [📷], you can capture night illumination scenery with slower shutter speed. (Max: about 8 seconds)
- When taking a picture in a dark place, noise may appear. To avoid noise, we recommend setting the picture adjustment to [NATURAL]. (P47)

Using the Color Effect Mode

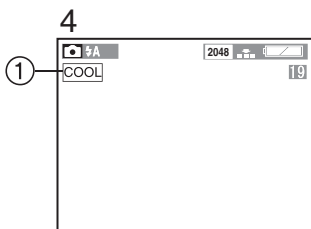
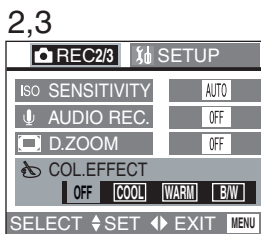
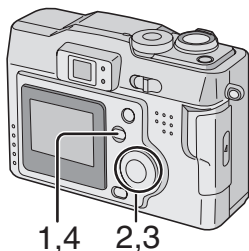

This function enables the use of 3 kinds of color effects.

[Preparation]

- Set the mode dial except for

[]/[♥]/[]. (P22)

- Press the [MENU] button.
- Press ▲/▼ to select [COL.EFFECT].
- Press ◀/▶ to select [OFF], [COOL], [WARM] or [B/W].
 - COOL: The picture becomes bluish.
 - WARM: The picture becomes reddish.
 - B/W: The picture becomes black and white.
- Press the [MENU] button.
 - The menu will disappear.
 - The indication [COOL/WARM/B/W] ① will appear.

Taking Pictures using Spot Mode

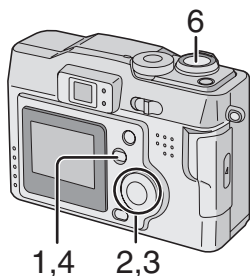

2,3

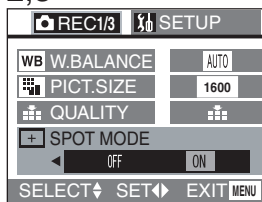

4

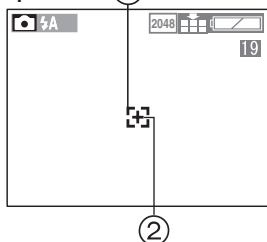

When this mode is selected, both the focus and the exposure will be adjusted to spot on a limited area. This is suitable when you take pictures in delicate light conditions and intend to take a picture of a specific area.

[Preparation]

- Set the mode dial except for

[][][]. (P22)

- 1 Press the [MENU] button.
- 2 Press $\blacktriangle/\blacktriangledown$ to select [SPOT MODE].
- 3 Press $\blacktriangleleft/\blacktriangleright$ to set to [ON].
- 4 Press the [MENU] button.
 - The menu will disappear.
 - The spot AF area ① and spot metering target ② appears.
- 5 Center the subject in the spot AF area.
- 6 Take a picture.

- When the subject is dark, the focus may not be adjusted properly.
- Background may become dark or whitish depending on the subject.
- If the subject is out of the spot AF area, use the AF/AE lock. (P46)

Compensating the Exposure

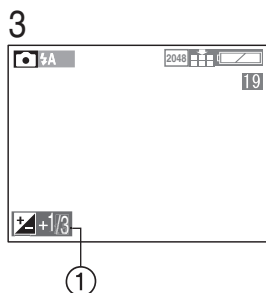
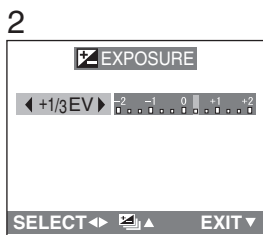
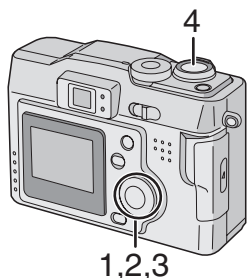

In some situations the illumination of the background and your subject may differ. Auto exposure systems may not always calculate the exposure correctly. This is a normal situation. This feature allows you to manually compensate the exposure.

[Preparation]

- Set the mode dial except for

[][][]. (P22)

- 1 Press the [] button.
- 2 Press / to compensate the exposure.

- You can compensate from -2 EV to $+2$ EV with $1/3$ EV step. (EV is an abbreviation of Exposure Value, and it is the amount of light given to the CCD by the aperture value and the shutter speed)
- The compensation state may be different from the recorded picture. Confirm the playback picture.

- 3 Press the /[REVIEW/SET] button.

- The compensation window will close.
- The compensation state is not reflected by the brightness of the LCD monitor.
- The exposure compensation indication ① will appear.

- 4 Take a picture.

- Depending on brightness of the subject, the range for which it is possible to compensate the exposure will be limited.

Taking Pictures using Auto Exposure (AE) Bracket

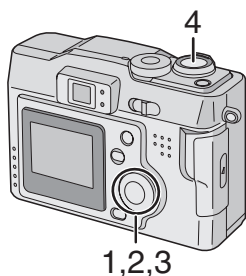

Pressing the shutter button once, the camera will automatically take 3 pictures changing exposure according to the set exposure compensation value.

[Preparation]

- Set the mode dial except for []/[]/[]/[]/[]/[]. (P22)

- 1 Press the []/[] button 2 times to select [] AUTO BRACKET.
- 2 Press ►, then press ◀/► to set the exposure compensation range.

- OFF
- -1 EV - +1 EV (1/3 EV step)

- 3 Press the ▼/[REVIEW/SET] button.

- The compensation window will close.
- The auto bracket indication ① appears.

- 4 Take a picture.

2

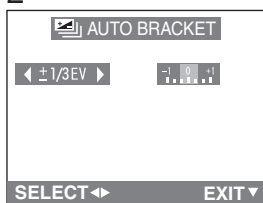

3

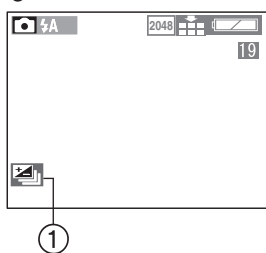

- Once you take a picture, auto bracket will be cancelled automatically.
- When flash fires, you can take only 1 picture. Auto bracket setting cannot be cancelled.
- When setting auto bracket, you cannot take a still picture with audio.
- Depending on the brightness of the subject, the range for which it is possible to compensate the exposure pictures using auto bracket will be limited.

Using the AF/AE Lock

Normally, the camera focuses in the center area of the picture. Depending on how you compose the photo, your subject may not be in the center. Using AF/AE Lock you can focus on your subject, reposition the camera, and the camera will maintain proper focus.

AF: Auto focus
AE: Auto exposure

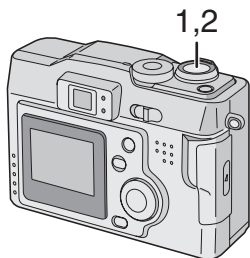

[Preparation]

- Set the mode dial except for [▶]. (P22)

1 Aim the camera at the subject on which you want to adjust the focus to enter the AF area ② on the LCD monitor and then keep pressing the shutter button halfway (AF/AE lock).

- When the focus is adjusted, the focus indication ① [●] appears.

2 Move the camera keeping the chosen composition and press the shutter button all the way.

- Before pressing the shutter button, you can set the AF/AE lock again and again.

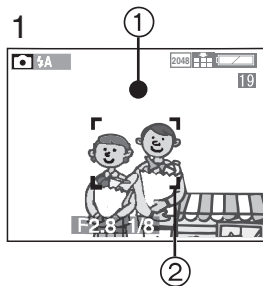

Adjusting the Color Tone or the Contrast (Picture Adjustment)

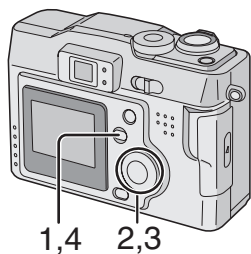

2,3

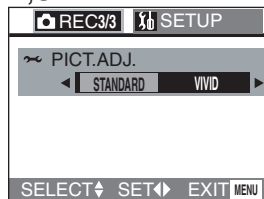

This function enables you to adjust the color tone or the contrast.

[Preparation]

- Set the mode dial except for

[] [] []. (P22)

- 1 Press the [MENU] button.
- 2 Press $\blacktriangle/\blacktriangledown$ to select [PICT.ADJ.].
- 3 Press $\blacktriangle/\blacktriangleright$ to select [NATURAL], [STANDARD] or [VIVID].

- [NATURAL]: The picture becomes softer.
- [VIVID]: The picture becomes sharper.

- 4 Press the [MENU] button.

- The menu will disappear.

- When using Vivid mode in low light situations it is possible that a slight increase in color noise will be seen. Proper lighting is recommended.

Setting the White Balance

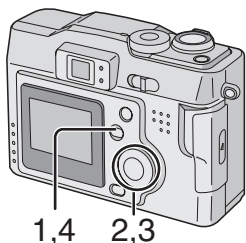

2,3

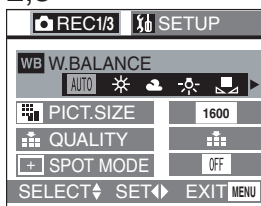

Auto White Balance is designed to automatically adjust the camera to produce natural flesh tones. In most situations it works fine. In some situations where several different types of lighting are present, enhanced performance can be achieved by setting the white balance manually.

[Preparation]

- Set the mode dial except for

[▶][♥][H]. (P22)

- 1 Press the [MENU] button.
- 2 Press ▲/▼ to select [W.BALANCE].
- 3 Press ◀/▶ to select the mode.
 - AUTO: if the auto white balance is set
 - [Daylight]: for recording outdoors on a bright day
 - [Cloudy]: for recording under a cloudy and shady sky
 - [Halogen]: for recording under halogen lighting
 - [White set]: for manual setting (Read the following page where the manual setting is explained in detail)
- 4 Press the [MENU] button.
 - The menu will disappear.

- The setting of the white balance is applied to the other recording modes.
- In simple mode [♥] or motion image mode [H], the white balance is fixed to [AUTO].
- When taking a picture with the flash, the white balance will be automatically adjusted (for AUTO and Halogen mode), but the white balance may not be properly adjusted when the flash light is insufficient.

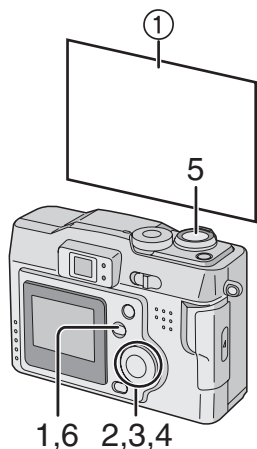

2,3

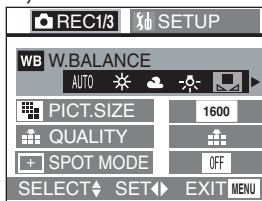

4

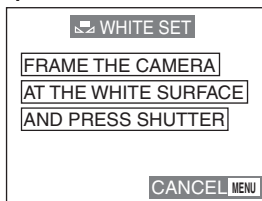

To set manually (White set)

Here the white set mode of white balance is explained.

[Preparation]

- Set the mode dial except for [] (P22)

1 Press the [MENU] button.

2 Press ▲/▼ to select [W.BALANCE].

3 Press ◀/▶ to set to white set [].

Only when setting the white balance again

4 Press ▶.

- The message "FRAME THE CAMERA AT THE WHITE SURFACE AND PRESS SHUTTER" is displayed.

5 Aim the camera at a sheet of white paper ① or similar object so that it completely fills the frame to white on the screen and press the shutter button all the way.

- White balance is set.

6 Press the [MENU] button.

- The menu will disappear.

- When taking a picture with the flash after setting the white balance manually, the white balance may not be properly adjusted. We recommend setting the white balance to [AUTO] when using the flash.

Setting ISO Sensitivity

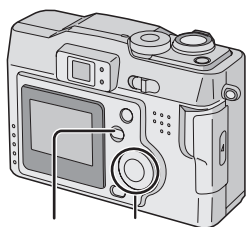

1,4 2,3

2,3

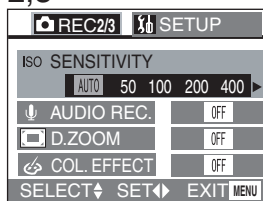

4

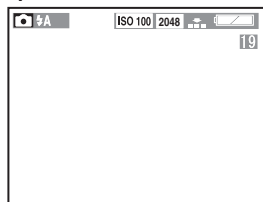

The ISO setting adjusts the camera's sensitivity to light. Generally, the lower the ISO setting, the better the picture quality will be. Increasing the ISO value will make the camera more sensitive in low light.

[Preparation]

- Set the mode dial except for

[][][]. (P22)

- 1 Press the [MENU] button.
- 2 Press $\blacktriangle/\blacktriangledown$ to select [SENSITIVITY].
- 3 Press $\blacktriangleleft/\blacktriangleright$ to select the sensitivity.

- AUTO: The ISO sensitivity is automatically adjusted. If your picture is still too dark, please use the flash.
- **50** ISO50
- **100** ISO100
- **200** ISO200
- **400** ISO400

- 4 Press the [MENU] button.





- The menu will disappear.

- In motion image mode [] or simple mode [], ISO sensitivity is fixed to [AUTO].
- When you take a picture in high ISO sensitivity, picture noise appears and the picture quality deteriorates.

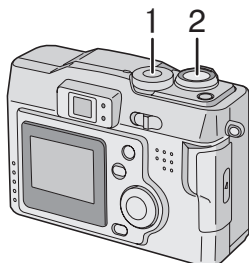

Taking Pictures using Burst Mode

By continuously pressing the shutter button, it is possible to record in burst mode.



	Burst speed	Number of recordable pictures	
			
 H	4 frames/second	5 frames	8 frames
 L	2 frames/second	5 frames	8 frames

[Preparation]

- Set the mode dial except for /. (P22)

1 Press .

- Every time you press it, what is displayed changes as shown below.





 H: High speed

 L: Low speed

When these indicators are not displayed, burst mode is cancelled.

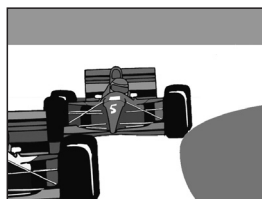
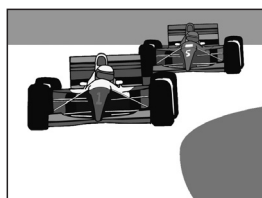
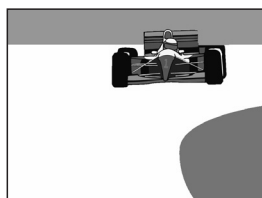
2 Press the shutter button halfway to lock the focus, then press it fully to take pictures in sequence.



- It is possible to record 4 frames in 1 second in burst mode, at a shutter speed higher than 1/60, but the flash does not fire simultaneously.
- If the flash fires, it is possible to record only 1 frame.
- In simple mode , the shutter speed is fixed to the low speed. (P27)
- You cannot take still pictures with audio in the burst mode.
- Burst mode will not perform as described if a MultiMediaCard is used in place of SD Memory Card. The reading/writing speed of a MultiMediaCard is slower than an SD Memory Card.

Playing Back Still Pictures

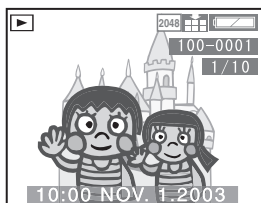
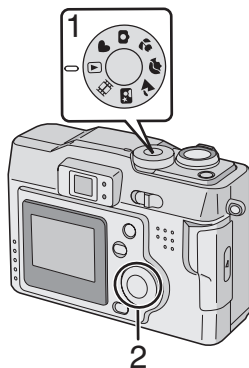

- 1 **Set the mode dial to playback** [▶].
 - The last recorded picture is played back.
- 2 **Press ◀ to play back the previous picture.**
Press ▶ to play back the next picture.
 - Every time you press ◀/▶, the previous (or next) picture is played back.
 - The first picture follows the last one.

[Fast forwarding/Fast rewinding]

During playback, continue pressing ◀/▶.





▶: Fast forward

◀: Fast rewind

- The file number increases/decreases. When releasing ◀/▶, the picture corresponding to the current file number is displayed.

- This camera is based on the DCF standards (Design rule for Camera File system) which were established by the Japan Electronics and Information Technology Industries Association (JEITA).
- The file format that can be played back with this camera is JPEG. (There are also pictures that cannot be played back in JPEG format)
- When playing back still pictures that have been recorded with other equipment, the quality of pictures may be deteriorated and pictures may not be able to be played back.
- When changing the folder name or file name on PC, the pictures may not be able to be played back.

Playing Back Still Pictures with Audio

- 1 Set the mode dial to playback [].
- 2 Press / to select the file with audio icon [] ①.
- 3 Press the /[REVIEW/SET] button to play back the audio.

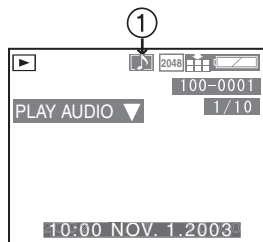
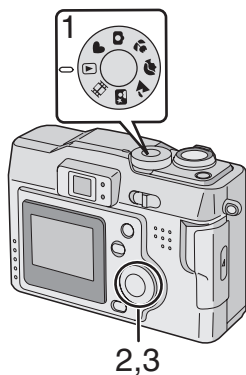

- Audio cannot be played back from this camera. Connect to a television to play back audio.

9 Images Multi Playback

It is possible to display 9 images at once.

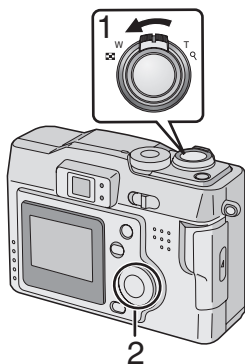

[Preparation]

- Set the mode dial to playback [▶]. (P22)

1 During playback, rotate the zoom lever towards [📐].

- Multi playback (9 frames) starts.

2 Press ▲/▼/◀/▶ to select images.

- To return to the normal indication, rotate the zoom lever towards [Q]. The image with the file number colored in yellow is displayed.

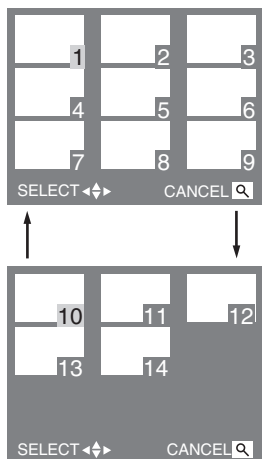

Using the Playback Zoom

During playback it is possible to enlarge pictures. (2 times/4 times/8 times/16 times)

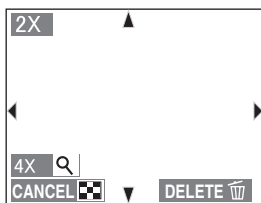
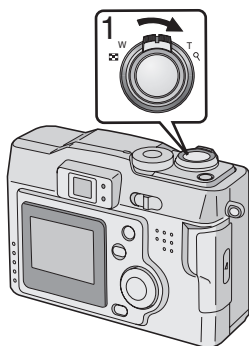

[Preparation]

- Set the mode dial to playback [▶]. (P22)

1 During playback, rotate the zoom lever towards [Q].

- The more the zoom lever rotates towards [Q], the more the zoom magnification ratio increases.
- The more the zoom lever rotates towards [W], the more the zoom magnification ratio decreases.
- Use ▲/▼/◀/▶ to change the area to be enlarged.

■ To delete a picture during the playback zoom

Press the [🗑️] button.

When this message is displayed “DELETE THIS PICTURE?”, press ◀/▶ to select [YES], and press the ▼/[REVIEW/SET] button. (P57)

- The more the zoom magnification increases, the more the picture quality deteriorates.
- The playback zoom may not operate if pictures have been recorded with other equipment.

Playing Back Motion Images

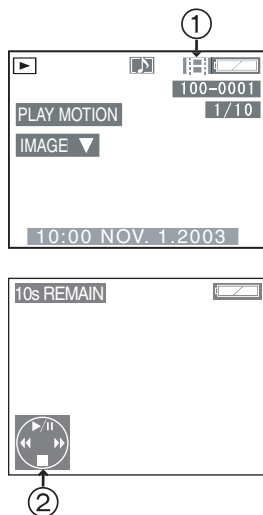
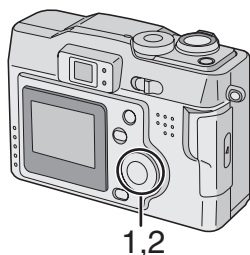

[Preparation]

- Set the mode dial to playback []. (P22)

- 1 Press to select the file with the motion image icon [] ①.
- 2 Press the /[REVIEW/SET] button to play back the motion image.

- By pressing , motion image playback will stop.
- The icon ② is corresponding to the button.

[Fast forwarding/Fast rewinding]

During motion image playback, continue pressing .

- ▶: Fast forward
- ◀: Fast rewind

- When releasing the button, it turns to normal motion image playback.

[To pause]

Press during motion image playback.

- Press again to cancel pause.

- **Audio cannot be played back from this camera. Connect to a television or PC to play back audio.**
- The play back zoom cannot be used while playing back motion images.
- The file format that can be played back with this camera is QuickTime Motion JPEG.
- It could happen that the Motion JPEG file recorded by a PC or other equipment cannot be played back with this camera.
- When playing back motion images that have been recorded with other equipment, the quality of images may be deteriorated or images may not be able to be played back.
- When using a high capacity Memory Card, it is possible that fast rewinding may be slower.

Deleting Images

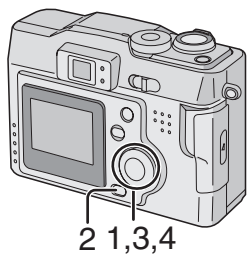

2,3



Images recorded on the card can be deleted. Once deleted, images cannot be recovered.

[Preparation]

- Set the mode dial to playback [P]. (P22)
- When an image is protected, it cannot be deleted. Cancel the protect setting. (P63)

[Delete single image]

- 1 Press **◀/▶** to select the image to be deleted.
- 2 Press [**🗑️**].
- 3 Press **◀** to select [YES].
- 4 Press the **▼/[REVIEW/SET]** button.
 - The selected image is deleted.

[Delete multi images]

It is possible to delete up to 50 images all at once.

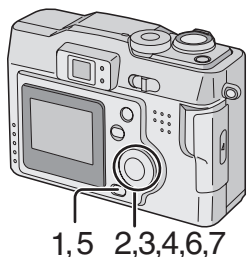

- 1 Press [] 2 times.
- 2 Press ▲/▼ to select [MULTI DELETE] and then press ▶.
- 3 Press ◀/▶ to select the images to be deleted.
- 4 Press the ▼/[REVIEW/SET] button.

- The selected images are displayed with []. Pressing the ▼/[REVIEW/SET] button again, the setting is cancelled.

- The indication [] blinks red if the selected image is protected. Cancel the protect setting. (P63)

2

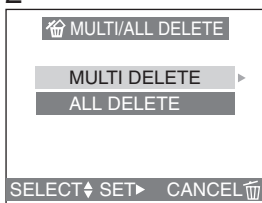

- 5 Press [].
- 6 When this message is displayed “DELETE THE PICTURES YOU MARKED?”, press ◀ to select [YES].

3,4

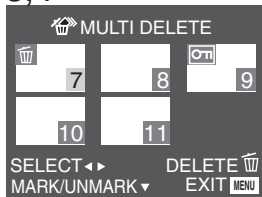

- 7 Press the ▼/[REVIEW/SET] button.

- The selected multi images are deleted all at once.

6



[Delete all images]

Once deleted, images cannot be recovered.

2

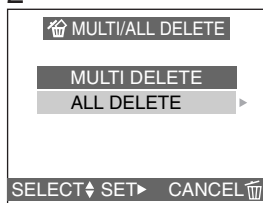

1 Press [] 2 times.

2 Press ▲/▼ to select [ALL DELETE] and then press ►.

3 When this message is displayed "DELETE ALL PICTURES?", press ◀/▶ to select [YES].

3

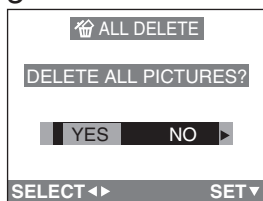

4 Press the ▼/[REVIEW/SET] button.

- Images that are protected or out of DCF standards (P52) are not deleted.

- Do not turn the power switch off or remove the card during deleting.
- When the remaining power is low or many pictures are deleted, use new batteries or the AC adaptor (optional, DMW-AC1).

Writing the Print Information to the Card (DPOF Setting)

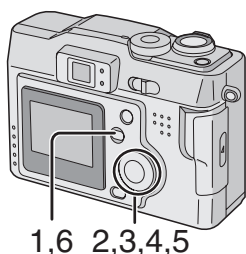

2,3



4

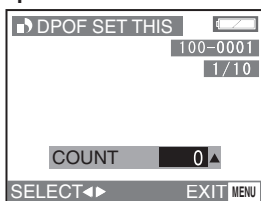

5

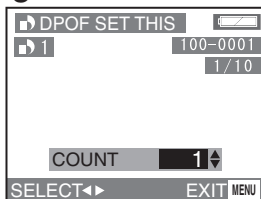

DPOF is the abbreviation for Digital Print Order Format. This feature allows you to designate which images will be printed. Some photo printers as well as many commercial photo-processing companies support DPOF.

[Preparation]

- Set the mode dial to playback []. (P22)

[Single copy setting]

- 1 Press the [MENU] button.
- 2 Press to select [DPOF PRINT] and then press .
- 3 Select [SINGLE] and then press .
- 4 Press to select 1 image.
- 5 Press to select the number of sheets.

- The number of sheets can be set from 1 to 999.

- 6 Press the [MENU] button 2 times.

- The menu will disappear.

[To cancel]

Set the number of sheets to 0 in step 5 of the [Single copy setting].

[Multi copy setting]

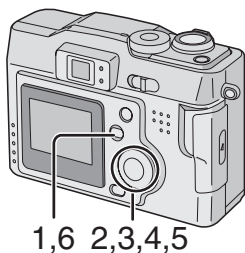

2,3



4

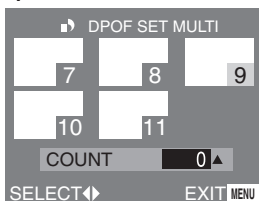

5

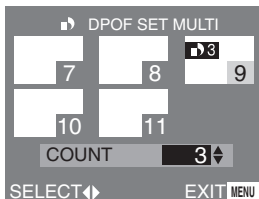

- 1 Press the [MENU] button.
- 2 Press ▲/▼ to select [DPOF PRINT] and then press ►.
- 3 Press ▲/▼ to select [MULTI] and then press ►.
- 4 Press ◀/▶ to select the image.
- 5 Press ▲/▼ to select the number of sheets to be printed.
 - The number of sheets can be set from 1 to 999.
- 6 Repeat steps 4 and 5, and at the end press the [MENU] button 2 times.
 - The DPOF setting of multi images is set at once.
 - The menu will disappear.

[To cancel]

Set the number of sheets to 0 in step 5 of the [Multi copy setting].

- If the file is not based on the DCF standard, the DPOF setting cannot be set. DCF is abbreviation of [Design rule for Camera File system], stipulated by JEITA [Japan Electronics and Information Technology Industries Association].
- When using the DPOF feature, this camera will overwrite any previous DPOF settings made by other products.

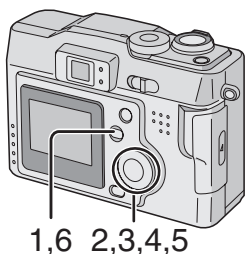

2,3

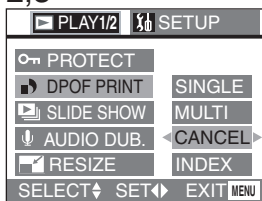

4

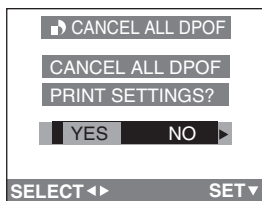

A

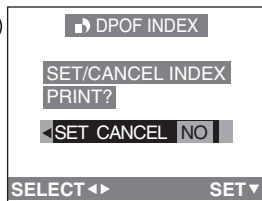

[To cancel all settings]

- 1 Press the [MENU] button.
- 2 Press ▲/▼ to select [DPOF PRINT] and then press ▶.
- 3 Press ▲/▼ to select [CANCEL] and then press ▶.
- 4 When this message is displayed "CANCEL ALL DPOF PRINT SETTINGS?", press ◀ to select [YES].
- 5 Press the ▼/[REVIEW/SET] button.
 - All DPOF settings are cancelled.
- 6 Press the [MENU] button.
 - The menu will disappear.

[Index setting/to cancel]

- 1 Press the [MENU] button.
- 2 Press ▲/▼ to select [DPOF PRINT] and then press ▶.
- 3 Press ▲/▼ to select [INDEX] and then press ▶.
- 4 When this message is displayed "SET INDEX PRINT?", press ◀ to select [YES].
 - When the index is already set, the message (A) "SET/CANCEL INDEX PRINT?" is displayed. Press ◀/▶ to select [SET], [CANCEL] or [NO].
- 5 Press the ▼/[REVIEW/SET] button.
 - All images are set/cancelled.
- 6 Press the [MENU] button.
 - The menu will disappear.

Protecting Images on the Card

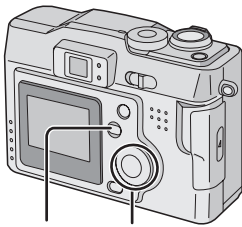

1,6 2,3,4,5

2,3

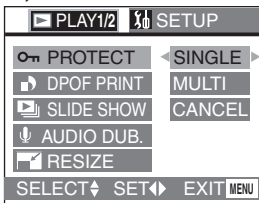

4,5

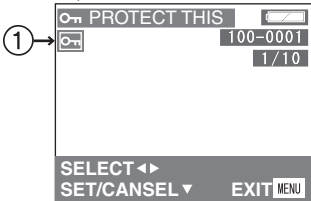

Using this feature, important photos can be protected from accidental deletion. This feature cannot protect photos or any data on the Card if the entire card is formatted.

[Preparation]

- Set the mode dial to playback [▶]. (P22)

[Single setting/to cancel]

- 1 Press the [MENU] button.
- 2 Press ▲/▼ to select [PROTECT] and then press ▶.
- 3 Press ▲/▼ to select [SINGLE] and then press ▶.
- 4 Press ◀/▶ to select 1 image.
- 5 Press the ▼/[REVIEW/SET] button.

- The protect icon ① appears.
- By pressing ▼/[REVIEW/SET] again, the protection is cancelled and the icon will disappear.

- 6 Press the [MENU] button 2 times.

- The menu will disappear.

[Multi setting/To cancel, To cancel all settings]

- 1 The method is the same as in “Writing the Print Information to the Card (DPOF Setting)”. (P60~P62)

- Formatting the card will erase all the data on the card, even if you protect the images in this procedure.
- When trying to delete a protected file, these messages are displayed “THIS PICTURE IS PROTECTED” or “PROTECTED PICTURES REMAIN UNDELETED”. If you want to delete this file, cancel the protect setting first.
- The protect setting may not be effective in other products.
- Sliding the SD Memory Card Write-Protect switch to [LOCK] prevents the picture from deletion even if the protection is not set.
- Audio dubbing cannot be used with protected images. (P66)

Playing Back with Slide Show (Automatic Playback)

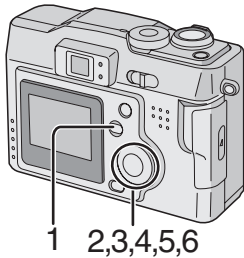

2,3

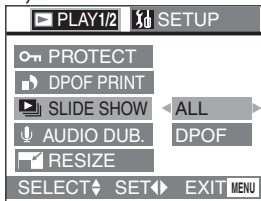

4

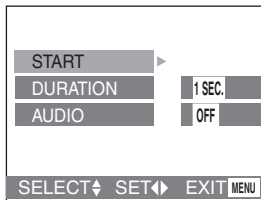

6



All pictures selected in the card can be played back one-by-one automatically.

[Preparation]

- Set the mode dial to playback [▶]. (P22)

- 1 Press the [MENU] button.
- 2 Press ▲/▼ to select [SLIDE SHOW] and then press ▶.
- 3 Press ▲/▼ to select [ALL]/[DPOF] and then press ▶.

- [ALL]: for playing back all pictures
- [DPOF]: for playing back the DPOF set pictures

- 4 Press ▲/▼/◀/▶ for setting below.

- [DURATION]: It can be set among 1, 2, 3 and 5 seconds.
- [AUDIO]: It can be set to [ON] or [OFF]. By setting it to [ON], it is possible to play back the still pictures with audio in slide show.
- [DPOF SET] (Only when setting to [DPOF]): You can select the pictures you want to set to the Slide Show.
- [CANCEL ALL] (Only when setting to [DPOF]): You can cancel the Slide Show setting.

- 5 Press ▲/▼ to select [START].

- 6 Press ▶.

- The slide show starts.
- By pressing the [MENU] button, it stops.

- In motion image playback, slide show is not available.
- The DPOF setting of slide show will not be applied to the DPOF printing.
- The setting time of the picture with audio is not reflected on [DURATION].
- **Audio cannot be played back from this camera. Connect to a television to play back audio.**
- When editing with the supplied software [SD Viewer for DSC] recorded on the CD-ROM, you can play back in SD slide show with this camera. (P90)
- Images that are set DPOF with the supplied software [SD Viewer for DSC] recorded on the CD-ROM cannot be played back in DPOF slide show with this camera. Set DPOF slide show on this camera.
- When using the DPOF feature, this camera will overwrite any previous DPOF settings made by other products.

Adding Audio to Recorded Pictures (Audio Dubbing)

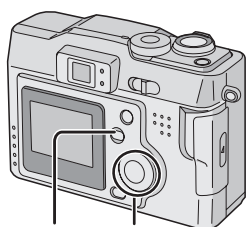

1,6 2,3,4,5

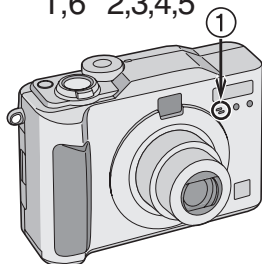

2



3,4

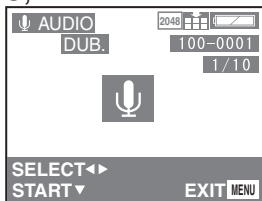

It is possible to add a 10-second narration to a recorded picture.

[Preparation]

- Set the mode dial to playback [▶]. (P22)

- 1 Press the [MENU] button.
- 2 Press ▲/▼ to select [AUDIO DUB.] and then press ▶.
- 3 Press ◀/▶ to select the picture.
- 4 Press the ▼/[REVIEW/SET] button, to start audio recording. (① Microphone)

- When audio has already been recorded, after the audio dubbing the original audio is overwritten.
- When audio has already been recorded, this message is displayed “OVERWRITE AUDIO DATA?”. Then press ◀/▶ to select [YES] and press the ▼/[REVIEW/SET] button, to start audio recording.

- 5 Press the ▼/[REVIEW/SET] button, to stop audio recording.

- Even if you do not press the ▼/[REVIEW/SET] button, after about 10 seconds the audio recording stops automatically.

- 6 Press the [MENU] button 2 times.

- The menu will disappear.

- Adding audio will use additional memory. Using this feature will result in fewer images being able to be saved.
- The audio dubbing cannot be used with motion images.
- The audio dubbing cannot be used with protected images.

Resizing Recorded Pictures

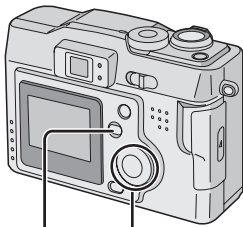

1,8 2,3,4,5,6,7
2



3

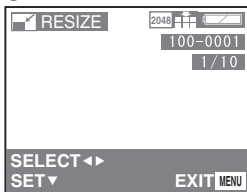

4

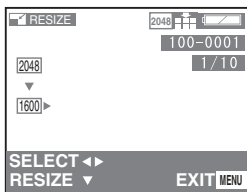

6



It is possible to reduce the recorded picture size. This function is useful if you want to reduce the volume of the picture for the purpose of attaching it to an e-mail or uploading it to a website.

[Preparation]

- Set the mode dial to playback []. (P22)

- 1 Press the [MENU] button.
- 2 Press $\blacktriangle/\blacktriangledown$ to select [RESIZE] and then press \blacktriangleright .
- 3 Press $\blacktriangle/\blacktriangleright$ to select the picture, and then press \blacktriangledown .
- 4 Press $\blacktriangle/\blacktriangleright$ to select the size.
 - : 1600×1200
 - : 1280×960
 - : 640×480
- 5 Press the \blacktriangledown /[REVIEW/SET] button to set the size.
- 6 When this message is displayed “DELETE ORIGINAL PICTURE?”, press $\blacktriangle/\blacktriangleright$ to select [YES] or [NO].
- 7 Press the \blacktriangledown /[REVIEW/SET] button.
- 8 Press the [MENU] button 2 times.

- The menu will disappear.

- It is not possible to resize pictures in a size lower than /equal to [640×480] or with an aspect ratio that is not 4:3.
- It may not be possible to resize the pictures recorded with other equipment.
- It is not possible to resize a motion image/still picture with audio.

Trimming Recorded Pictures

It is possible to cut off the unnecessary parts of the picture (trimming), and enlarge the remaining parts of the picture.

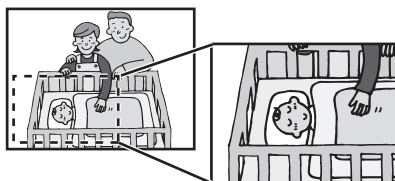
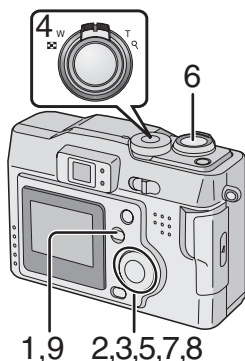

[Preparation]

- Set the mode dial to playback ([P]). (P22)

- 1 Press the [MENU] button.
- 2 Press $\blacktriangle/\blacktriangledown$ to select [TRIMMING] and then press \blacktriangleright .
- 3 Press $\blacktriangleleft/\blacktriangleright$ to select the picture, and then press \blacktriangledown .
- 4 Rotate the zoom lever towards [Q] to make subject appear closer, and towards [W] to make subjects appear further away.
- 5 Press $\blacktriangle/\blacktriangledown/\blacktriangleleft/\blacktriangleright$ to shift pictures.
- 6 Press the shutter button to set.

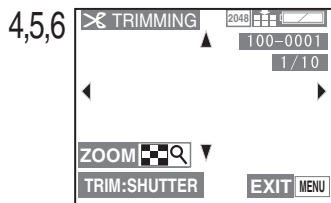
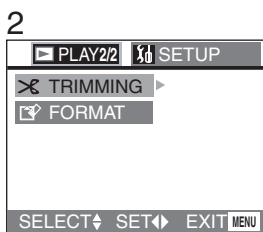

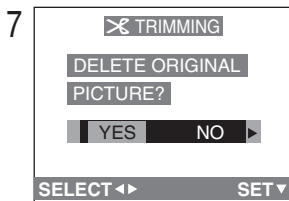

7 When this message is displayed “DELETE ORIGINAL PICTURE?”, press ◀/▶ to select [YES] or [NO].

8 Press the ▼/[REVIEW/SET] button.

9 Press the [MENU] button 2 times.

- The menu will disappear.

- Trimming images will use additional memory if the original image is saved.
- It is not possible to resize pictures in a size lower than [640×480] or with an aspect ratio that is not 4:3.
- You cannot operate trimming on pictures recorded with other equipment.
- Trimming is not possible for a motion image/still picture with audio.
- The picture size of the trimmed pictures may become smaller than that of the original one depending on the cut size.
- The picture quality of the trimmed picture becomes inferior.

Formatting the Card

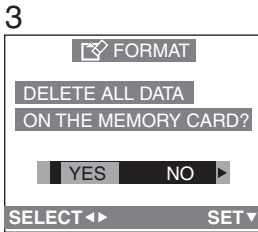
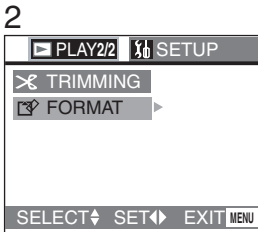
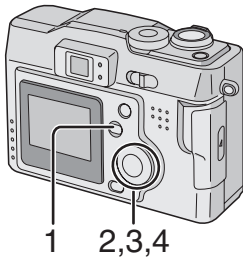

Usually, it is not necessary to format the card (initializing). Format the card when this message is displayed “MEMORY CARD ERROR”.

- If the card has been formatted by a PC or other equipment, format the card on the camera again.

[Preparation]

- Set the mode dial to playback [P]. (P22)

- 1 Press the [MENU] button.
- 2 Press ▲/▼ to select [FORMAT] and then press ►.
- 3 When this message is displayed “DELETE ALL DATA ON THE MEMORY CARD?”, press ◀/▶ to select [YES].
- 4 Press the ▼/[REVIEW/SET] button.

- The card is formatted.
- After formatting, recorded images and any other data cannot be recovered.

- When formatting, use the batteries which the remaining power is enough or AC adaptor (optional, DMW-AC1).
- During formatting, do not turn the power off.
- If the card cannot be formatted, consult your dealer.

For USA assistance, please call: 1-800-272-7033 or send e-mail to : digitalstillcam@panasonic.com

For Canadian assistance, please call: 1-800-561-5505 or visit us at www.panasonic.ca

Adjusting the LCD Monitor Brightness

You can adjust the brightness of the LCD monitor.

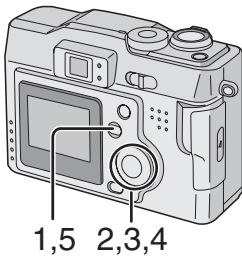

3,4

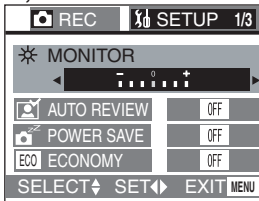

[Preparation]

- Press the [DISPLAY] button to select the display of LCD monitor. (P20)
- Set the mode dial except for [♥]. (P22)

- 1 Press the [MENU] button.
- 2 Press ► to open the setup menu.
- 3 Press ▲/▼ to select [MONITOR].
- 4 Press ◀/▶ to adjust the brightness.
- 5 Press the [MENU] button.

- The menu will disappear.

- In simple mode [♥], LCD monitor brightness is fixed to [0].

- Adjusting the LCD monitor will not lighten or darken the actual photograph.
- Adjusting the LCD monitor to brighten the image may incorrectly display the scene to be brighter than the actual photo will be. In most cases the default setting will produce the best performance and closest reproduction of the actual scene.

Using the Auto Review

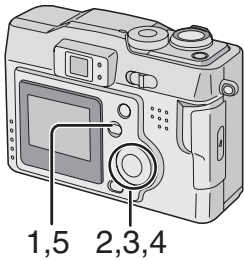

3,4

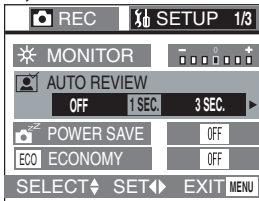

Recording with the auto review set to [1SEC.]/[3SEC.] the recorded picture is automatically displayed on the LCD monitor for 1 or 3 seconds.

[Preparation]

- Set the mode dial except for [▶]/[♥]. (P22)

- 1 Press the [MENU] button.
- 2 Press ▶ to open the setup menu.
- 3 Press ▲/▼ to select [AUTO REVIEW].
- 4 Press ◀/▶ to select [1SEC.] or [3SEC.].
- 5 Press the [MENU] button.

- The menu will disappear.

- Even when setting the auto review to [1SEC.]/[3SEC.], it is not available in motion image mode [H].
- When recording in burst mode, auto bracket, still picture with audio modes, the recorded picture is automatically displayed.
- In simple mode [♥], the auto review setting becomes [ON] (2 seconds) or [OFF].

Setting up the Operational Sound

It is possible to set the sound volume when the menu operations are done.

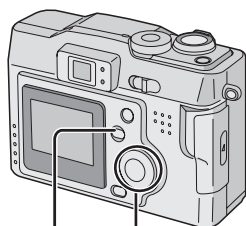

1,5 2,3,4

3,4

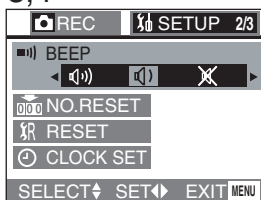

- 1 Press the [MENU] button.
- 2 Press ► to open the setup menu.
 - In simple mode, skip this step.
- 3 Press ▲/▼ to select [BEEP].
- 4 Press ◀/▶ to adjust the operational sound volume.
- 5 Press the [MENU] button.
 - The menu will disappear.

- In simple mode [♥], the setting becomes [ON] or [OFF].

Setting up the Power Save Mode

In this mode, if the camera is not operated for a certain amount of time, it is automatically turned off.

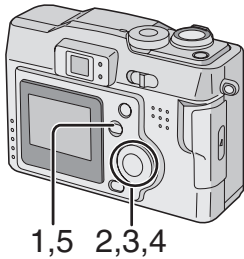

3,4

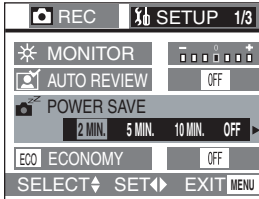

- 1 Press the [MENU] button.
- 2 Press ► to open the setup menu.
- 3 Press ▲/▼ to select [POWER SAVE].
- 4 Press ◀/▶ to choose the setting time.
 - [2 MIN.]
 - [5 MIN.]
 - [10 MIN.]
 - [OFF]: The power is not turned off automatically.
- 5 Press the [MENU] button.
 - The menu will disappear.

- If you want to cancel the power save mode, turn the power switch to [ON] again after turning it to [OFF], or press the shutter button.
- When using AC adaptor (optional, DMW-AC1)/recording the motion image/playing back the motion image/during slide show, the power save mode is not available.
- In simple mode [♥], the power save is fixed to [2 MIN.].

Saving the Power Consumption (Economy mode)

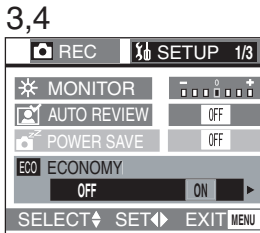
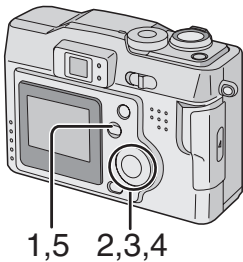

If the camera is not operated for about 15 seconds, the LCD monitor display turns off and power consumption is saved.

- When setting [ECONOMY] to [ON], the LCD monitor display is turned off while charging the flash.
- When setting [ECONOMY] to [ON], power save setting time is fixed to [2 MIN.].

[Preparation]

- Set the mode dial except for [▶]/[♥]. (P22)

- 1 Press the [MENU] button.
- 2 Press ▶ to open the setup menu.
- 3 Press ▲/▼ to select [ECONOMY].
- 4 Press ▶ to select [ON].
- 5 Press the [MENU] button.

- The menu will disappear.

- The message [MONITOR OFF] flashes for a few seconds before LCD monitor display is turned off.
- The LCD monitor turns on when pressing any button.

- When using AC adaptor (optional, DMW-AC1)/recording the motion image, the economy mode is not available.
- The economy mode does not work when the menu screen is displayed or the self-timer is set.

Resetting the File Number

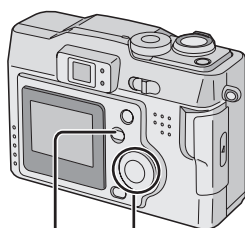

3

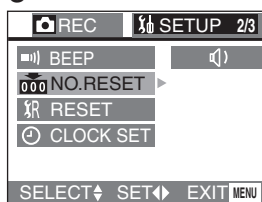

4

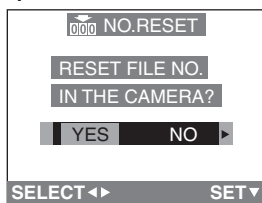

As the file numbers are recorded sequentially by the camera, when you use two or more cards, it may happen that the file numbers on your cards do not start from 0001.

Use this function when you insert a new card or perform the new recording on the recorded card and you want to start recording from the file number 0001.

[Preparation]

- Set the mode dial except for []/[♥]. (P22)

- 1 Press the [MENU] button.
- 2 Press ► to open the setup menu.
- 3 Press ▲/▼ to select [NO.RESET] and then press ►.
- 4 When this message is displayed “RESET FILE NO. IN THE CAMERA?”, press ◀ to select [YES].
- 5 Press the ▼/[REVIEW/SET] button.
- 6 Press the [MENU] button.
 - The menu will disappear.

Initializing the settings

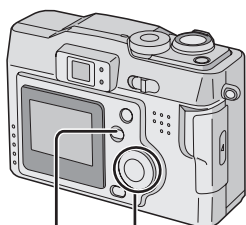

1,8 2,3,4,5,6,7

3

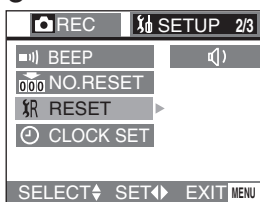

4



6

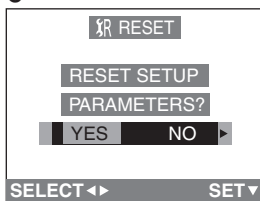

This feature allows you to easily reset the camera to the factory default settings.

[Preparation]

- Set the mode dial except for [▶]/[♥]. (P22)

- 1 Press the [MENU] button.
- 2 Press ▶ to open the setup menu.
- 3 Press ▲/▼ to select [RESET] and then press ▶.
- 4 When this message is displayed “RESET REC SETTINGS?”, press ◀ to select [YES].
- 5 Press the ▼/[REVIEW/SET] button.
 - The message “REC SETTING RESET COMPLETED” is displayed for about 2 seconds.
- 6 When this message is displayed “RESET SETUP PARAMETERS?”, press ◀ to select [YES].
- 7 Press the ▼/[REVIEW/SET] button to set.
 - The clock setting is not reset.
- 8 Press the [MENU] button.
 - The menu will disappear.

Playing Back Images with a TV Monitor

By connecting the camera to a television via the supplied A/V cable ①, it is possible to view and play back the recorded images.

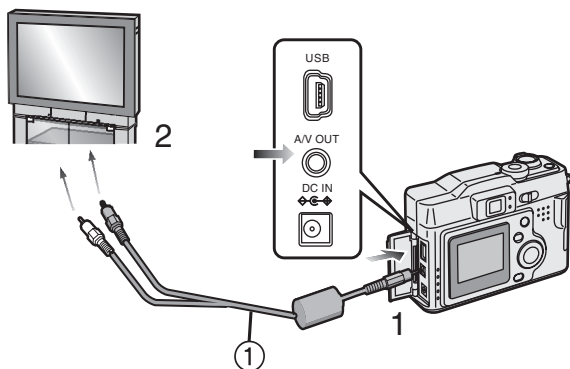

[Preparation]

- Turn the camera and the television off.

- 1 Connect the A/V cable ① to the A/V OUT socket of the camera.**
- 2 Connect the A/V cable to the video in and the audio in sockets of the TV.**
 - Yellow: to the video in socket
 - White: to the audio in socket
- 3 Turn the television on and select external input.**
- 4 Turn the camera on and then set the mode dial to playback [▶].**
 - The image is displayed on the television.

■ Viewing images in other countries

When setting [VIDEO OUT] on the menu, you can view images on a TV in other countries (regions) which use the NTSC or PAL system.

- Even if you set menu selection for [VIDEO OUT] to [PAL], the output signal is still NTSC.
- When connecting to a TV, use new batteries or the AC adaptor (optional, DMW-AC1).
- Do not use any other cables except the supplied one.
- The A/V cable cannot be connected to the “antenna” connection of your television. Your TV must provide separate audio and video connections for this feature to operate correctly.
- Read the TV operating instructions too.

Connecting to a PC

[Preparation]

- If your PC uses Microsoft Windows[®] 98 or Windows[®] 98 Second Edition, a USB driver must be installed from the CD that is included. If you are using a newer Microsoft operating system such as Windows[®] Me, Windows[®] 2000, or Windows[®] XP (Home Edition/Professional), no USB driver needs to be installed. Your PC should recognize the camera automatically.

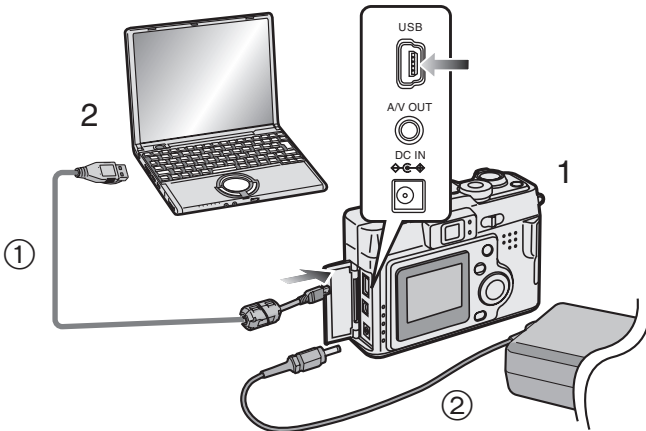

- 1 **Insert the Memory Card into the camera, and turn the power switch to [ON].**
- 2 **Connect the camera to a PC via the supplied USB connection cable ①.**

[Windows]

The drive is shown on the [My Computer] folder.

- If it is the first time you are connecting the camera to a PC, the required driver is installed automatically so that the camera can be recognized by the Windows Plug and Play, then it is shown on the [My Computer] folder.

[Macintosh]

The drive is shown on the screen.

- The flash/access indicator lights during access.
- When the battery power is lost during access, the data may be destroyed. The battery indicator does not appear. When connecting to a PC, use new batteries or the AC adaptor ② (optional, DMW-AC1).
- When connecting to a PC, pictures and sounds are not output from the A/V OUT socket.
- For further information (software installation), read the operating instructions for PC connection.

USB DIRECT-PRINT

By connecting the camera to a printer corresponding to USB DIRECT-PRINT via the supplied USB connection cable, it is possible to print directly.

(Please ask the manufacturer of the printer about the corresponding models)

(Read the printer operating instructions too)

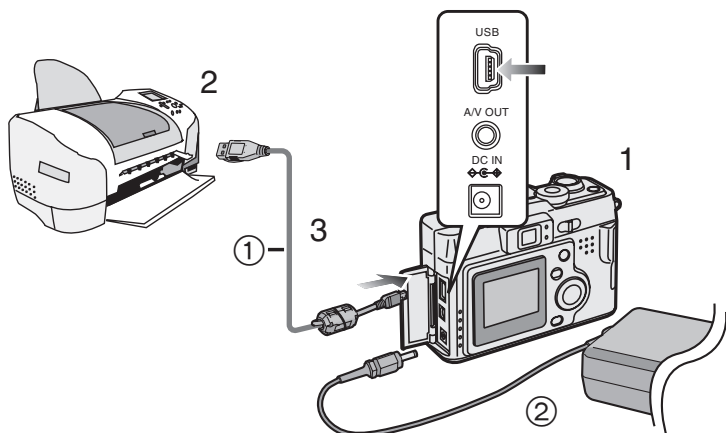

- 1 Insert the Memory Card into the camera, and turn the power switch to [ON].
- 2 Turn on the printer.
- 3 Connect the camera to the printer via the supplied USB cable ①.

- When connecting to a printer, use the batteries which the remaining power is enough or AC adaptor ② (optional, DMW-AC1).
- Disconnect the USB connection cable and DC cable after printing.

USB DIRECT-PRINT (Single Picture)

[Preparation]

- Connect the camera to a printer. (P80)

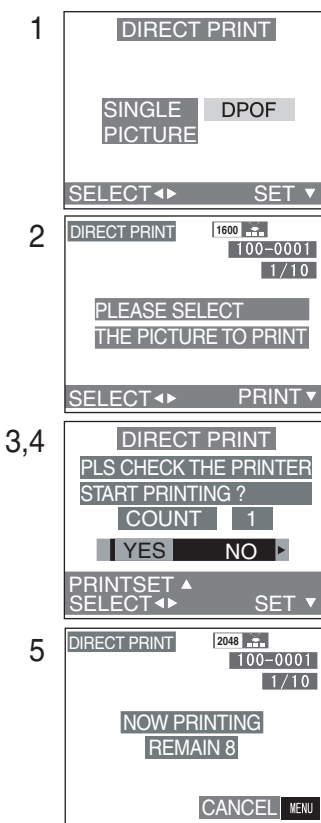

- 1 **Only when DPOF is already set, press ◀ to select [SINGLE PICTURE], and then press the ▼/[REVIEW/SET] button.**

- When DPOF is not set, this screen is skipped.

- 2 **Press ◀/▶ to select the picture to be printed, and then press the ▼/[REVIEW/SET] button.**

- The message "PLEASE SELECT THE PICTURE TO PRINT" is displayed for 2 seconds.

- 3 **Press ▲, and press ◀/▶ to set the number of sheets, and then press the ▼/[REVIEW/SET] button.**

- 4 **Press ◀ to select [YES].**

- The message "PLS CHECK THE PRINTER START PRINTING ?" is displayed.

- 5 **Press the ▼/[REVIEW/SET] button.**

- Printing starts.

- Press the [MENU] button, and you can stop printing.

USB DIRECT-PRINT (DPOF)

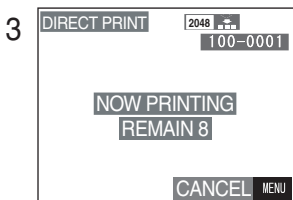
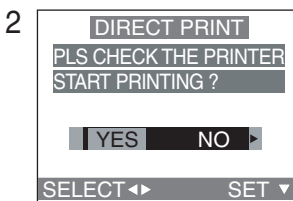
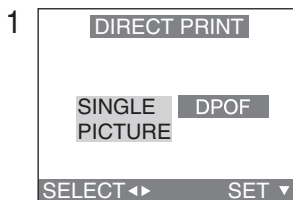

[Preparation]

- Connect the camera to a printer. (P80)
- Write the print information to the card (DPOF setting). (P60)

1 Press **◀/▶** to select [DPOF].

- Press the [MENU] button, and you can change the DPOF setting. (P60)

2 Press the **▼**/[REVIEW/SET] button.

- The message “PLS CHECK THE PRINTER START PRINTING ?” is displayed.

3 Press **◀** to select [YES], and then press the **▼**/[REVIEW/SET] button.

- Printing starts.

- Press the [MENU] button, and you can stop printing.

- When the number of total images is more than 255, the number of remaining images will be displayed as “----”.

Using the Optional AC Adaptor

If you use an AC adaptor (optional, DMW-AC1), you can use the camera without worrying about battery discharge.

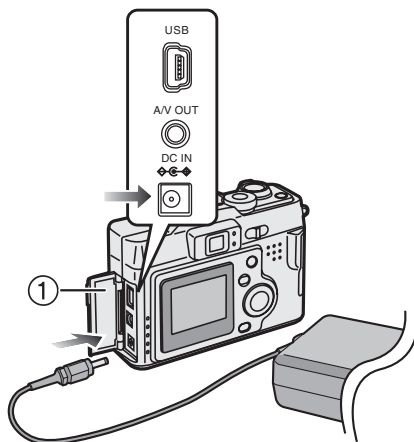

[Preparation]

- Check that the power switch is set to [OFF] and the lens is stored.

1 Connect the AC power plug to the AC outlet.

THE SOCKET OUTLET SHALL BE INSTALLED NEAR THE EQUIPMENT AND SHALL BE EASILY ACCESSIBLE.

2 Open the terminal door.

3 Connect the AC adaptor to the DC IN socket.

- Do not use the AC adaptor other than the optional one (DMW-AC1).
- The camera becomes warm during use, however, this is not a malfunction.
- The battery cannot be charged in the camera with the AC adaptor connected.
- When disconnecting/connecting the AC adaptor with the power switch turned on using the batteries, the data in the card may be destroyed or operation may be impossible. Be sure to disconnect/connect the AC adaptor after turning the power switch to off.

After Use

After using the camera and following the steps below, it is recommended to place it in the optional soft case for protection.

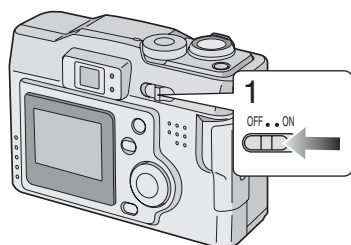

- 1 Turn the power switch to [OFF]. (P18)
- 2 Eject the card. (P16)
- 3 Remove the batteries.

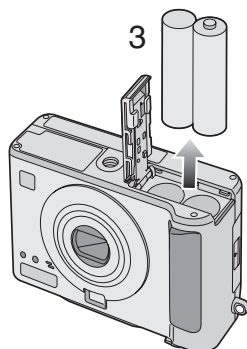
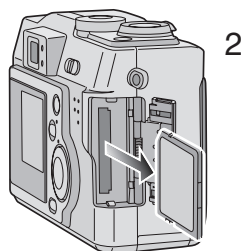

- If you will not be using the camera for a long time, remove the batteries. (When you insert the batteries again, set the date/time)

The Menu Items

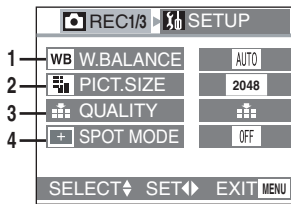

REC mode menu

- 1 W.BALANCE (P48)
- 2 PICT.SIZE (P36)
- 3 QUALITY (P37)
- 4 SPOT MODE (P43)

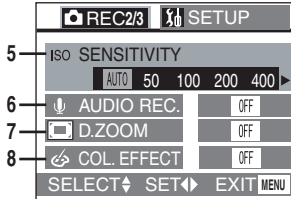

- 5 SENSITIVITY (P50)
- 6 AUDIO REC. (P35)
- 7 D.ZOOM (P31)
- 8 COL.EFFECT (P42)

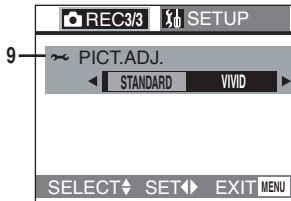

- 9 PICT.ADJ. (P47)

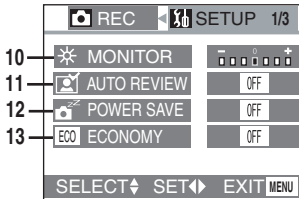

- 10 MONITOR (P71)
- 11 AUTO REVIEW (P72)
- 12 POWER SAVE (P74)
- 13 ECONOMY (P75)

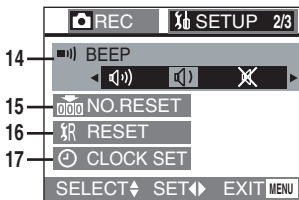

- 14 BEEP (P73)
- 15 NO.RESET (P76)
- 16 RESET (P77)
- 17 CLOCK SET (P24)



- 18 LANGUAGE

Simple mode menu

- For items without number, refer to those with the same name.

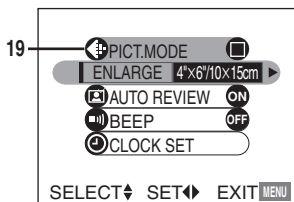

19 PICT.MODE (P27)

Playback mode menu

- For items without number, refer to those with the same name.

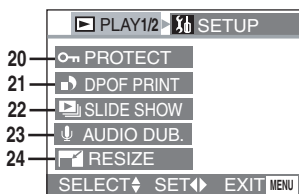

20 PROTECT (P63)

21 DPOF PRINT (P60)

22 SLIDE SHOW (P64)

23 AUDIO DUB. (P66)

24 RESIZE (P67)

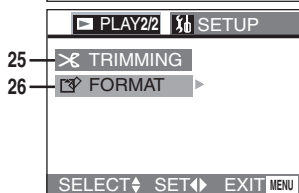

25 TRIMMING (P68)

26 FORMAT (P70)

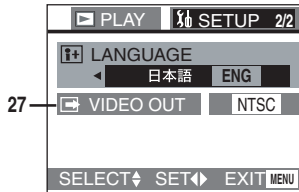
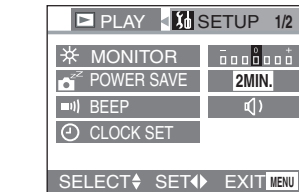

27 VIDEO OUT (P78)

Cautions for Use

■ Cautions for Use

Keep the digital camera away from magnetized equipment (such as a microwave oven, TV, video game equipment, etc.).

- If you use the digital camera on or near a TV, images and sounds may be disturbed due to electromagnetic wave radiation.
- Do not use the digital camera near a cell phone because doing so may cause noise to adversely affect the images and sounds.
- Recorded data may be damaged, or images may be distorted by strong magnetic fields created by speakers or large motors.
- Electromagnetic wave radiation generated by a microprocessor may adversely affect the digital camera, causing the disturbance of images and sounds.
- If the digital camera is affected by magnetically charged equipment and does not function properly, turn the camera off and detach the batteries and then connect the batteries again. Thereafter, turn the camera on.

Do not use the digital camera near radio transmitters or high-voltage lines.

- If you record near radio transmitters or high-voltage lines, recorded images or sounds may be adversely affected.

Do not spray insecticides or volatile chemicals onto the digital camera.

- If the digital camera is sprayed with such chemicals, the camera body may be damaged and the surface finish may peel off.
- Do not keep rubber or plastic products in contact with the digital camera for a long period of time.

When you use the digital camera on a beach or similar place, do not let sand or fine dust get into the camera.

- Sand or dust may damage the digital camera or card. (Care should be taken when inserting and removing the card)

When you use your digital camera on a rainy or snowy day or on a beach, make sure that no water enters the digital camera.

- Water may cause the digital camera or card to malfunction. (Irreparable damage may occur)
- If sea water splashes onto the digital camera, wet a soft cloth with tap water, wring it well, and use it to wipe the camera body carefully. Then, wipe it again thoroughly with a soft dry cloth.

Do not use the digital camera for surveillance purposes or other business use.

- If you use the digital camera for a long period of time, the internal temperature increases and, consequently, this may cause malfunction.
- The digital camera is not intended for business use.

Do not use benzine, thinner or alcohol for cleaning the digital camera.

- The camera body may be deformed and the surface finish may peel off.
- Before cleaning the camera, detach the batteries.
- Wipe the digital camera with a soft, dry cloth. To remove stubborn stains, wipe with a cloth that is soaked in a detergent diluted with water and afterward finish wiping with a dry cloth.
- For storing or transporting the digital camera, place it in a bag or case lined with soft pads to prevent the coating on the camera body from being worn.

After use, be sure to take the card out, and detach the batteries.

- If the batteries are left on the digital camera for a long time, the voltage drops excessively.

Be sure to remove the batteries after use.

Be sure to remove the batteries from the digital camera. (If they are left attached to the digital camera, a minute amount of current is consumed even when the digital camera power is off) If the batteries are left attached to the digital camera for a long time, discharge takes place.

Dispose of unusable batteries.

- The batteries have a limited life.
- Do not throw the batteries into fire because it may cause an explosion.

Always keep the terminals of the batteries clean.

Prevent the terminals from getting clogged with dirt, dust, or other substances.

If you drop the battery accidentally, check to see if the battery body and terminals are deformed. Attaching a deformed battery to the digital camera may damage the camera.



A nickel metal hydride battery that is recyclable powers the product you have purchased. Please call 1-800-8-BATTERY for information on how to recycle this battery.

■ Condensation

When condensation has taken place:

Set the power switch to [OFF] and leave the digital camera in this condition for about 1 hour. When the camera becomes close to the ambient temperature, the fog disappears naturally.

■ Cautions for Storage

Before storing the digital camera, take the card out and detach the batteries. Store all the components in a dry place with a relatively stable temperature. (Recommended temperature: 59 °F to 77 °F (15°C to 25°C), Recommended humidity: 40 to 60%)

Digital camera

- Wrap it with a soft cloth to prevent dust from getting into the camera.
- Do not leave the camera in places that expose it to high temperature.

Batteries

- Do not leave the camera and the battery in places where the temperature is too high, such as inside the car during the summer.
- Extremely high or low temperatures will shorten the life of batteries.
- If the batteries are kept in smoky or dusty places, the terminals may rust and cause malfunctions.
- Do not allow the battery terminals to come in contact with metal objects (such as necklaces, hairpins, etc.). This can result in a short circuit or heat generation, and if you touch the battery in this condition, you may be badly burned.

Card

- When the card is being read, do not remove the card, turn off the power, or subject it to vibration or impact.
- Do not leave the card in places where there is high temperature or direct sunlight, or where electromagnetic waves or static electricity are easily generated.
- Do not bend or drop the card. The card or the recorded content may be damaged.
- After use, be sure to remove the card from the digital camera.
- Do not touch the terminals on the back of the card with your fingers. Do not allow dirt, dust or water to enter it.

■ LCD monitor

LCD monitor

- In a place with drastic temperature changes, condensation may form on the LCD monitor. Wipe it with soft dry cloth.
- If the digital camera is extremely cold when you turn the power on, the image on the LCD monitor is slightly darker than usual at first. However, as the internal temperature increases, it goes back to the normal brightness.

Extremely high precision technology is employed to produce the LCD monitor screen featuring a total of approximately 114,000 pixels. The result is more than 99.99% effective pixels with a mere 0.01% of the pixels inactive or always lit. However, this is not a malfunction and does not affect the recorded picture.

■ SD Slide Show

If setting the SD slide show with the [SD Viewer for DSC] which is in the supplied CD-ROM, when playing back, the message "START SD SLIDE SHOW?" is displayed. Select [YES] and press the ▼/[REVIEW/SET] button to start the SD slide show. Select [NO] and press the ▼/[REVIEW/SET] button to start normal playback.

■ Folder Composition

When a Memory Card with data recorded on it is inserted into a PC, the folders shown below will be displayed.

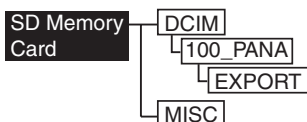

- In the 100_PANA folder it is possible to record up to 999 images.
- In the MISC folder it is possible to record the files that have been set with DPOF settings.

Message Indications

[NO MEMORY CARD]

Insert the Memory Card.

[THIS MEMORY CARD IS PROTECTED]

Cancel the Memory Card lock.

[NO VALID IMAGE TO PLAY]

Carry out playback after recording or after inserting the Memory Card with a recorded image.

[MEMORY CARD FULL]/[NOT ENOUGH MEMORY IN THE CARD]

Insert a new Memory Card or delete unnecessary data.

[MEMORY CARD ERROR]

Failed access to Memory Card.
Insert the card again.

[READ ERROR]

Data reading error.
Play it back again.

[WRITE ERROR]

Data writing error.
Turn the camera [OFF] and remove the card. Then insert the card and turn the camera back [ON]. Be sure camera is [OFF] before removing or inserting the card to avoid damaging the card.

[SYSTEM ERROR]

When the camera does not work correctly because of the pressure to the lens, this message is displayed. Turn the power switch to [ON] again.

[PLEASE SET THE CLOCK]

This message is displayed when you use the camera for the first time or you do not use the camera for a long time. Set the clock again.

[THIS PICTURE IS PROTECTED]

After cancelling the protect setting, you can delete or overwrite the image.

[THIS PICTURE CAN'T BE DELETED]/[SOME PICTURES CAN'T BE DELETED]

If the image is not based on the DCF standard, it is not possible to delete selected pictures.

[NO ADDITIONAL DELETE SELECTIONS CAN BE MADE]

You have exceeded the number of images that can be set at once with multi-deleting setting.

[CAN'T BE SET ON THIS PICTURE]/[CAN'T BE SET ON SOME PICTURES]

If the image is not based on the DCF standard, it is not possible to set the DPOF or audio dubbing.

[MEMORY CARD ERROR FORMAT THIS CARD?]

The format of this card cannot be recognized by the camera. Format the card again with the camera.

[MODE DIAL IS NOT IN THE PROPER POSITION]

This message is displayed when you turn on the camera with the mode dial in the wrong position.
Rotate the mode dial to the proper position.

Troubleshooting

1: The power does not turn on.

- 1-1: Are the batteries inserted? Check whether the batteries are inserted.
- 1-2: Is the battery power sufficient?

2: As the power is turned on, it turns off immediately.

- 2-1: Is the battery power insufficient to operate the camera? Replace it with new one.
- 2-2: Are the batteries other than the recommended ones?

3: The image cannot be recorded.

- 3-1: Is the Memory Card inside?
- 3-2: Is the mode dial correctly set? Check it.
- 3-3: There is no memory capacity left on the card. Before recording, delete some images.

4: The image is not displayed on the LCD monitor.

- 4-1: Is the LCD monitor set to OFF?
- 4-2: Does the economy mode work?

5: The LCD monitor is too bright or dark.

- 5: Adjust the brightness of the LCD monitor.

6: Flash does not light.

- 6: The flash mode is set to forced OFF. Change the flash mode.

7: The display or images on the LCD monitor are not focused.

- 7: Set the mode dial to the mode corresponding to the distance to the subject.

8: The image will not play back.

- 8-1: Is the Memory Card inside?
- 8-2: There is no image in the Memory Card.
- 8-3: The mode dial is not set to playback [].

9: The image is not displayed on the television.

- 9-1: Is the camera correctly connected with the TV? Check it.
- 9-2: Set the TV to video input mode.

10: When connecting to a PC, images cannot be transferred.

- 10-1: Check that the camera is correctly connected to the PC.
- 10-2: Is the camera correctly recognized by the PC?

11: The clock setting is reset.

- 11-1: If you do not use the camera for a long time, the clock setting may be reset. When the message [PLEASE SET THE CLOCK] appears, set the clock again.
- 11-2: When you take a picture before setting the clock, [0.0.0 0:00] is recorded.

Specifications

Digital Camera



Information for your safety

Power Consumption:	1.7 W (When recording with LCD monitor to on) 0.7 W (When recording with LCD monitor to off) 1.0 W (When playing back with LCD monitor)
Effective number of pixels	3.2 Million Pixels
Image sensor	1/2.5" CCD, total pixel number 3,340,000 Primary color filter
Lens	Optical 3× zoom, f=5.8 - 17.4 mm (35 mm film camera equivalent: 35 - 105 mm)/F2.8 - 4.9
Digital zoom	Max 3×
Focus	Auto/Macro Normal/Spot AF change (Spot mode)
Focus range	Auto: 1.64 feet (50 cm)(Wide)/1.64 feet (50 cm) (Tele) - ∞ , Macro/Simple: 0.33 feet (10 cm) (Wide)/1.64 feet (50 cm) (Tele) - ∞
Shutter system	Electronic shutter + Mechanical shutter
Burst recording	4 frames/second, Max 8 frames (standard)/ 5 frames (fine) (Performance is only with SD Memory Card. MultiMediaCard performance will be less.)
Motion image recording	320×240 pixels (10 frames/second with audio)
ISO sensitivity	AUTO/50/100/200/400
Shutter speed	8 - 1/2,000 Motion image mode: 1/30 - 1/2,000
White balance	AUTO/Daylight/Cloudy/Halogen/White set
Exposure (AE)	Program AE Exposure compensation (1/3 EV Step, -2 - +2 EV)
Metering mode	Multi/Spot (Spot mode)
LCD monitor	1.5" low-temperature polycrystalline TFT LCD (114,000 pixels) (field of view ratio 100%)
Optical finder	Real-image zoom finder
Flash	Flash range: (ISO100) Approx. 0.98 feet (30 cm) - 7.87 feet (2.4 m) (Wide) /Approx. 1.64 feet (50 cm) - 4.59 feet (140 cm) (Tele) AUTO, AUTO/Red-eye reduction, Forced ON, Slow sync./Red-eye reduction, Forced OFF
Microphone	Monaural
Recording media	SD Memory Card/MultiMediaCard
Recording size	2048×1536 pixels, 1600×1200 pixels, 1280×960 pixels, 640×480 pixels (Still picture) 320×240 (Motion image)
Quality	Fine/Standard

Others

Recording file format	
Still Picture	JPEG (Design rule for Camera File system, based on Exif 2.2 standard), DPOF corresponding
Still picture with audio	JPEG (Design rule for Camera File system, based on Exif 2.2 standard) + 640×480 QuickTime Motion JPEG (still picture with audio)
Motion image	QuickTime Motion JPEG (motion image with audio)
Interface	
Digital	USB
Analog video/audio	NTSC/PAL Composite/Audio line output (monaural)
Terminal	
USB	5 pin Mini USB
Analog video/audio	Ø 2.5 mm jack
DC IN	EIAJ type 1 jack
Dimensions (W × H × D)	3 4/5" × 2 1/2" × 1 1/3" /96×65.5×34 mm (excluding the projection part)
Weight	Approx. 6 oz/170 g (excluding Memory Card and battery) Approx. 7.58 oz/215 g (with Memory Card and battery)
Operating Temperature	32 °F - 104 °F (0°C - 40°C)
Operating Humidity	10% - 80%
Power Source	AA Alkaline batteries (2 pieces) AA Ni-MH (nickel-metal hydride) batteries (2 pieces) AC adaptor (DMW-AC1) (optional)

Digital Camera Accessory System

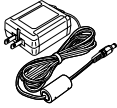
Accessory#	Figure	Description
RP-SDH512 RP-SDH256 RP-SD128B RP-SD064B RP-SD032B RP-SD016B		512 MB SD Memory Card 256 MB SD Memory Card 128 MB SD Memory Card 64 MB SD Memory Card 32 MB SD Memory Card 16 MB SD Memory Card
BN-SDCAPU/1B		SD USB Reader/Writer (compatible with MultiMediaCard)
BN-SDABPU/1B		SD PC Card Adaptor (compatible with MultiMediaCard)
DMW-AC1		AC Adaptor

Please refer to page 15, for details on available recording time.

*NOTE: Accessories and/or model numbers may vary by country. Please consult your local dealer.

Digital Camera Accessory Order Form

(For USA Customers)

Please photocopy this form when placing an order.

1. Digital Camera Model # _____

2. Items Ordered

Accessory #	Description	Price Each	Quantity	Total Price
Subtotal				
Your State & Local Sales Tax				
Shipping & Handling				6.95
Total Enclosed				

3. Method of payment (check one)

- Check of Money Order enclosed (NO C.O.D.SHIPMENTS)
- VISA Credit Card # _____
- MasterCard Expiration Date _____
- Discover Customer Signature _____

Make Check or Money Order to: PANASONIC ACCESSORIES

(Please do not send cash)

4. Shipping information (UPS delivery requires complete street address)

Ship To:

Mr.

Mrs.

Ms.

First

Last

Phone#:

Day () _____

Street Address

Night () _____

City

State

Zip

TO OBTAIN ANY OF OUR DIGITAL CAMERA ACCESSORIES YOU CAN DO ANY OF
THE FOLLOWING:

VISIT YOUR LOCAL PANASONIC DEALER

OR

CALL PANASONIC'S ACCESSORY ORDER LINE AT 1-800-332-5368

[6 AM-5 PM M-F, 6 AM-10:30 AM SAT, PACIFIC TIME]

OR

MAIL THIS ORDER TO: PANASONIC SERVICES COMPANY ACCESSORY ORDER OFFICE

20421 84th Avenue South Kent, WA. 98032

In CANADA, please contact your local Dealer for more information on
Accessories.

Request for Service Notice (For USA Only)

Please photocopy this form when making a request for service notice.

In the unlikely event this product needs service.

Request for Service Notice: (USA Only)

- Please include your **proof of purchase.**
(Failure to do so will delay your repair.)
- To further speed your repair, please provide an explanation of what wrong with the unit and any symptom it is exhibiting.

Mail this completed form and your Proof of Purchase along with your unit to:

Panasonic Services Company
1705 N. Randall Road
Elgin, IL. 60123-7847
Attn: Digital Camera Repair

Please write the displayed above Self Diagnostic number here.

Limited Warranty (For USA Only)

PANASONIC CONSUMER
ELECTRONICS COMPANY,
DIVISION OF MATSUSHITA
ELECTRIC CORPORATION OF
AMERICA, One Panasonic Way
Secaucus, New Jersey 07094

PANASONIC SALES COMPANY,
DIVISION OF MATSUSHITA
ELECTRIC OF PUERTO RICO, INC.
Ave. 65 de Infanteria, Km. 9.5, San
Gabriel Industrial Park, Carolina,
Puerto Rico 00985

Panasonic Digital Still Camera Limited Warranty

Limited Warranty Coverage

If your product does not work properly because of a defect in materials or workmanship, Panasonic Consumer Electronics Company or Panasonic Sales Company (collectively referred to as "the warrantor") will, for the length of the period indicated on the chart below, which starts with the date of original purchase ("warranty period"), at its option either (a) repair your product with new or refurbished parts, or (b) replace it with a new or refurbished product. The decision to repair or replace will be made by the warrantor.

PRODUCT OR PART NAME	PARTS	LABOR
DIGITAL STILL CAMERA (EXCEPT ITEMS LISTED BELOW)	1 (ONE) YEAR	90 (NINETY) DAYS
CCD	6 (SIX) MONTHS	90 (NINETY) DAYS
RECHARGEABLE BATTERY PACK (IN EXCHANGE FOR DEFECTIVE BATTERY PACK)	90 (NINETY) DAYS	NOT APPLICABLE
SD MEMORY CARD (IN EXCHANGE FOR DEFECTIVE SD CARD)	90 (NINETY) DAYS	NOT APPLICABLE

During the "Labor" warranty period there will be no charge for labor. During the "Parts" warranty period, there will be no charge for parts. You must carry-in or mail-in your product during the warranty period. If non-rechargeable batteries are included, they are not warranted. This warranty only applies to products purchased and serviced in the United States or Puerto Rico. This warranty is extended only to the original purchaser of a new product which was not sold "as is". A purchase receipt or other proof of the original purchase date is required for warranty service.

Carry-In or Mail-In Service

For Carry-In or Mail-In Service in the United States call

1-800-272-7033.

For assistance in Puerto Rico call Panasonic Sales Company

(787)-750-4300 or fax (787)-768-2910.

This warranty ONLY COVERS failures due to defects in materials or workmanship, and DOES NOT COVER normal wear and tear or cosmetic damage. The warranty ALSO DOES NOT COVER damages which occurred in shipment, or failures which are caused by products not supplied by the warrantor, or failures which result from accidents, misuse, abuse, neglect, mishandling, misapplication, alteration, faulty installation, set-up adjustments, misadjustment of consumer controls, improper maintenance, power line surge, lightning damage, modification, or commercial use (such as in a hotel, office, restaurant, or other business), rental use of the product, service by anyone other than a Factory Servicenter or other Authorized Servicer, or damage that is attributable to acts of God.

THERE ARE NO EXPRESS WARRANTIES EXCEPT AS LISTED UNDER "LIMITED WARRANTY COVERAGE". THE WARRANTOR IS NOT LIABLE FOR INCIDENTAL OR CONSEQUENTIAL DAMAGES RESULTING FROM THE USE OF THIS PRODUCT, OR ARISING OUT OF ANY BREACH OF THIS WARRANTY. (As examples, this excludes damages for lost time, travel to and from the servicer, loss of media or images, data or other memory content. The items listed are not exclusive, but are for illustration only.) **ALL EXPRESS AND IMPLIED WARRANTIES, INCLUDING THE WARRANTY OF MERCHANTABILITY, ARE LIMITED TO THE PERIOD OF THE LIMITED WARRANTY.**

Some states do not allow the exclusion or limitation of incidental or consequential damages, or limitations on how long an implied warranty lasts, so the exclusions may not apply to you.

This warranty gives you specific legal rights and you may also have other rights which vary from state to state. If a problem with this product develops during or after the warranty period, you may contact your dealer or Servicenter. If the problem is not handled to your satisfaction, then write to the warrantor's Consumer Affairs Department at the addresses listed for the warrantor.

PARTS AND SERVICE WHICH ARE NOT COVERED BY THIS LIMITED WARRANTY ARE YOUR RESPONSIBILITY.

Customer Services Directory (For USA Only)

For Product Information, Operating Assistance, Literature Request, Dealer Locations, and all Customer Service inquiries please contact:

1-800-272-7033, Monday-Friday 8:30am-8pm EST.

Web Site: <http://www.panasonic.com>

You can purchase parts, accessories or locate your nearest servicer by visiting our Web Site.

Accessory Purchases:

1-800-332-5368 (Customer Orders Only)

Panasonic Services Company 20421 84th Avenue South, Kent, WA 98032

(6 am to 5 pm Monday - Friday; 6 am to 10:30 am Saturday; PST)

(Visa, MasterCard, Discover Card, American Express, Check)

Product Repairs

Centralized Factory Servicer

MAIL TO :

Panasonic Services Company
1705 N. Randall Road,
Elgin, IL 60123-7847
Attention: Digital Camera Repair

Please carefully pack and ship, prepaid and insured, to the Elgin Centralized Factory Servicer.

Customer's in Puerto Rico, please ship or carry in to location below ("Service in Puerto Rico").

Service in Puerto Rico

Matsushita Electric of Puerto Rico, Inc. Panasonic Sales Company/ Factory Servicer:

Ave. 65 de Infantería, Km. 9.5, San Gabriel Industrial Park, Carolina, Puerto Rico 00985

Phone (787) 750-4300 Fax (787) 768-2910

As of January 2002

Index

A

AF/AE Lock	46
Audio Dubbing	66
Auto Exposure (AE) Bracket	45
Auto Review	72

B

Built-in Flash	32
Burst Mode	51

C

Clock Set	24
Condensation	89

D

Digital Zoom	31
DPOF	60

E

Economy mode	75
--------------------	----

F

File Number	76
Flash/Access Indicator	18
Formatting	70

I

ISO Sensitivity	50
-----------------------	----

L

Landscape Mode	40
LCD Monitor Brightness	71

M

Macro Mode	38
Motion Image	29
Multi Playback	54
MultiMediaCard	17

N

Night Portrait Mode	41
---------------------------	----

O

Operational Sound	73
Optical Zoom	30

P

Picture Size	36
Play Back	52
Playback Zoom	55
Portrait Mode	39
Power Save Mode	74

Q

Quality	37
---------------	----

R

Resize	67
Review	28

S

SD Memory Card	17
SD Slide Show	90
Self-timer	34
Slide Show	64
Spot Mode	43

T

Trimming	68
----------------	----

U

USB Direct Printing	80
---------------------------	----

W

White Balance	48
---------------------	----

Spanish Quick Use Guide/Guía española para el uso rápido

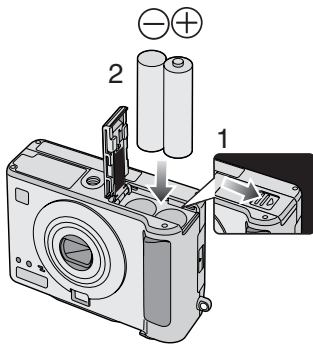

Prepare las siguientes piezas.

- Cámara
- Baterías
- Tarjeta

- Compruebe que el interruptor de alimentación esté ajustado a [OFF] y esté almacenado el objetivo.

[Preparaciones]

- 1 Haga deslizar la tapa en la dirección de la flecha para abrir la tapa de las baterías.
- 2 Inserte las baterías en la cámara.
 - Inserte las baterías poniendo cuidado en la dirección de las polaridades \oplus y \ominus .
- 3 Cierre la tapa de la batería.
- 4 Para abrir la tapa de la tarjeta de memoria, desplace la tapa en la dirección de la flecha.
- 5 Introduzca la tarjeta en la cámara.
- 6 Cierre la tapa de la tarjeta de memoria.

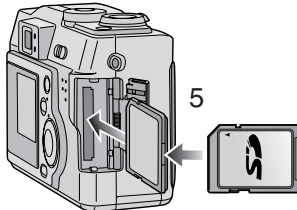
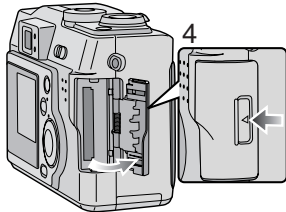

[Grabación]

- 7 Ponga el interruptor de alimentación a [ON]. (P18)
- 8 Defina la fecha/hora.
- 9 Ajuste el disco del modo a la imagen normal [M].
- 10 Saque una imagen.

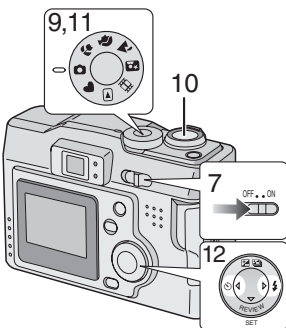

[Reproducción]

- 11 Ajuste el disco del modo a la reproducción [▶].
- 12 Pulse \leftarrow/\rightarrow para reproducir la imagen que quiere ver.

Memo

**Panasonic Consumer Electronics Company,
Division of Matsushita Electric Corporation of America**
One Panasonic Way, Secaucus, NJ 07094

**Panasonic Sales Company ("PSC")
Division of Matsushita Electric of Puerto Rico, Inc.**
Ave. 65 de Infanteria, Km. 9.5, San Gabriel Industrial Park, Carolina, Puerto Rico 00985

Panasonic Canada Inc.
5770 Ambler Drive, Mississauga, Ontario, L4W 2T3



VQT0D36